

**NOVA-7896/7896FW**  
**Celeron™ , Pentium® III Processor**  
**Multimedia & Dual Ethernet ,IEEE1394**  
**Embedded Board**

©Copyright 2001 by ICP Electronics Inc. All Rights Reserved. Manual first edition February.8, 2001.

The information in this document is subject to change without prior notice in order to improve reliability, design and function and does not represent a commitment on the part of the manufacturer.

In no event will the manufacturer be liable for direct, indirect, special, incidental, or consequential damages arising out of the use or inability to use the product or documentation, even if advised of the possibility of such damages.

This document contains proprietary information protected by copyright. All rights are reserved. No part of this manual may be reproduced by any mechanical, electronic, or other means in any form without prior written permission of the manufacturer.

**Trademarks**

NOVA-7896/7896FW is a registered trademark of ICP Electronics Inc. IBM PC is a registered trademark of International Business Machines Corporation. Intel is a registered trademark of Intel Corporation. AWARD is a registered trademark of Award Software Internation, Inc. Other product names mentioned herein are used for identification purposes only and may be trademarks and/or registered trademarks of their respective companies.

# Contents

1. Introduction.....	4
1.1 Specifications .....	5
1.2 What You Have .....	7
2. Installation.....	8
2.1 NOVA-7896/7896FW Layout.....	9
2.2 NOVA-7896/7896FW Dimension .....	10
2.3 Unpacking Precautions.....	11
2.4 Setting the CPU of NOVA-7896/7896FW .....	12
2.5 Clear CMOS Setup .....	12
2.6 COM 2 RS-232 / 422 / 485 Setup.....	13
2.7 COM PORT RI and Voltage Selection .....	13
2.8 LCD Panel power Setup.....	15
2.9 LCD Panel Type Selection.....	16
2.10 CompactFlash™ Disk Setting .....	16
3. Connection .....	17
3.1 Floppy Disk Drive Connector.....	17
3.2 PCI E-IDE Disk Drive Connector .....	18
3.3 Parallel Port.....	18
3.4 Serial Ports.....	19
3.5 Keyboard/Mouse Connector .....	21
3.6 External Switches and Indicators.....	22
3.7 USB Port Connector.....	22

3.8 IrDA Infrared Interface Port .....	23
3.9 VGA Connector.....	23
3.10 LAN RJ45 Connector .....	23
3.11 Fan Connector.....	24
3.12 Temperature Sensor Connector .....	25
3.13 Audio CD IN Connector.....	25
3.14 Audio Speaker OUT Connector .....	25
3.15 Audio Panel Connector .....	25
3.16 Compact Flash Connector.....	26
3.17 Power Connector .....	27
3.18 LCD Back-light Connector.....	27
3.19 Digital Input / Output Connector .....	27
3.20 LCD Panel Connector .....	28
3.21 IEEE1394 Connector .....	29

## 4. AWARD BIOS Setup .....

4.1 Introduction.....	30
4.2 Starting Setup.....	30
4.3 Using Setup.....	31
4.4 Getting Help.....	32
4.5 Main Menu.....	33
4.6 Standard CMOS Setup.....	36
4.7 Advanced BIOS Features Setup .....	40
4.8 Advanced Chipset Features Setup.....	45
4.9 Integrated Peripherals Setup .....	52

4.10	Power Management Setup .....	56
4.11	PnP/PCI Configuration Setup .....	60
4.12	PC Health Status Setup .....	62
4.13	Frequency / Voltage Control Setup .....	64
4.14	Defaults Menu Setup .....	65
4.15	Change Supervisor/User Password.....	66
4.16	Exit Selection .....	67
 <b>Appendix A. WatchDog Timer .....</b>		<b>68</b>
 <b>Appendix B. POST Messages .....</b>		<b>70</b>
 <b>Appendix C.</b>		
<b>DMA , IRQ , 1st MB Memory and I/O Address Map...76</b>		
 <b>Appendix D. How to Upgrade a New BIOS .....</b>		<b>78</b>
 <b>Appendix E. Digital Input / Output Address .....</b>		<b>81</b>
 <b>Appendix F. Flat Panel Connection Module.....</b>		<b>83</b>
<b>Appendix G. Dual View Setup</b>		
<b>.....85</b>		

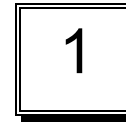

## Introduction

Welcome to the NOVA-7896/7896FW Socket 370 Celeron<sup>®</sup> , Pentium III<sup>®</sup> (FC-PGA) with two 10/100Mbps Ethernet , VGA , IEEE1394 , Audio Board. It is equipped with high performance Intel<sup>®</sup> Celeron up to 700MHz( or above ) , Pentium III ( FC-PGA ) 500-933MHz ( or above ) Processor and advanced high performance multi-mode I/O, designed for the system manufacturers, integrators, or VARs that want to provide all the performance, reliability, and quality at a reasonable price.

This board has a built-in IDE Interface CompactFlash<sup>™</sup> Disk ( Type II ) for embedded application. The CompactFlash<sup>™</sup> Disk is 100% compatible to hard disk. User can use any DOS command without any extra software utility. The Flash Disk currently is available from 128MB to 1GB.

Two advanced high performance LPC super I/O chip – ITE ( IT8705F ) and NS ( NS87366 ) is used in the NOVA-7896/7896FW board. The on-chip UARTs are compatible with the NS16C550. The parallel port and FDD interface are compatible with IBM PC/AT architecture.

NOVA-7896/7896FW uses the advanced SIS SIS630 Chipset which is 100% PCI compatible chipset with PCI 2.1 standard. In addition, this board provides one 168-pin sockets for its on-board DRAM. The DIMM module is 3.3V SDRAM and max. 512MB for each module.

The VGA chip ( On chip sis300) used on NOVA-7896/7896FW supports dual view function which can display simultaneously on

two monitors when you enter WINDOWS 9X/ME. In general, this function is achieved by two VGA chips.

---

## 1.1 Specifications :

- **CPU** : support Intel Celeron® up to 677 MHz ( or above ) , Pentium III ( FC-PGA ) 500-933 MHz (or Above ) Processor. Supports 66MHz, 100MHz and 133 MHz FSB.
- **Expansion Bus** : PCI & PC104 bus( PCI and ISA bus), expansion to support PCI and ISA ( Slave mode only ) bus signal
- **DMA channels** : 7
- **Interrupt levels** : 15
- **Chipset** : SIS630 66/100/133MHz CPU / DRAM Clock
- **DRAM** : One 168-pin DIMM socket ,supports SDRAM RAM module, up to 512MB.
- **AGP VGA Controller** : On chip SIS300 3D ( Share memory up to 64MB RAM)  
AGP bus speed : 66MHz  
VESA Compatible Resolution Graphic Mode up to  
  
1600 x 1200 256/32K colors 100 Hz  
1280 x 1024 256/32K/64K/16M colors 120 Hz  
1024 x 768 256/32K/64K/16M colors 120 Hz  
800 x 600 16/256/32K/64K/16M colors 120 Hz  
640 x 480 16/256/32K/64K/16M colors 120 Hz
- **Support 3.3V Flat Panel.**
- **Support 24bit TFT wide range flat panel.**
- **Optional ( LVDS-01 ) One Channels LVDS module.**

- **10/100Mbps Ethernet Controller** : Two Ethernet - Realtek 8139C and SIS900 ( embedded in SIS630 chipset ), Auto-sensing interface to 10Mbps, 100Mbps Network , RJ45 connector for 10BASE-TX and 100BASE-TX , Full Duplex capability , Full Software driver support
- **Ultra DMA/66 (Enhanced PCI IDE Interface)** : Supports two PCI Enhance IDE hard drives. The Ultra DMA/66 IDE can handle data transfer up to 66MB/s. The best of all is that this new technology is compatible with existing ATA-2 IDE specifications. So, there is no need to do any change for customer's current accessory.
- **Multi-I/O Chip** : IT8705F,NS87366, all I/O setup by BIOS  
Three 16C550 RS-232C Ports One RS-232 or RS-422/485 Port  
One EPP/ECP Parallel Port, Floppy Port. The RS485 features auto-direction control. No extra direction control is needed.
- **Floppy disk drive interface** : Two 2.88 MB, 1.44MB, 1.2MB, 720KB, or 360KB floppy disk drives.
- **Four high speed Serial ports** : NS16C550 compatible UARTs
- **Bi-directional Parallel Port** : One parallel port support, IEEE 1284 compatible .
- **IrDA port** : Support Infrared and Amplitude Shift Keyed IR(ASKIR) interface.
- **USB port** : Support Two USB ports for future expansion. USB V1.2 compatible .
- **Watchdog timer** : Supports resolution of 1 sec and period of 1-255 secs . Reset is generated when CPU does not periodically trigger the timer. You can uses IO port – 443H to control the watch-dog .
- **CompactFlash Disk** – Type II CompactFlash™ Disk . The Flash Disk provides 100% compatibility with IDE hard disk.
- **Digital I/O** : Isolated 4 Digital Input and 4 Digital Output channels
- **SIS7018 PCI Audio Chipset**: Sound Blaster compatible and Roland MPU401 compatible ( AC97 )
- **Support ATX Power function**
- **Dual View Function**

- **Mouse & Keyboard Connector** : PS/2 Mouse Port Expansion Keyboard.
- **Power Consumption** : +5V : 7.5A (Pentium III 933MHz, 256MB SDRAM ) +12V : 0.3A
- **Operating Humidity** : 5 ~ 95 % , non-condensing
- **Operating Temperature** : 0° ~ 55° C ( CPU needs Cooler)

If any of these items is missing or damaged, contact the dealer from whom you purchased the product. Save the shipping materials and carton in case you want to ship or store the product in the future.

---

## 1.2 What You Have

In addition to this *User's Manual*, the NOVA-7896/7896FW package includes the following items:

- NOVA-7896/7896FW Socket 370 Celeron® , Pentium III & Dual Ethernet , IEEE1394 ,VGA , Audio Board
- FDD/HDD ( 1x2.54mm and 1x2.54mm Support DMA66)Cable ( 32200-000017 / 32200-000052 )
- Keyboard / Mouse Adapter Mini Dim Cable x1 ( 32000-000159 / 32000-000153 )
- Printer / Serial Port ( 1xRS232 ) Cable x1 ( 32000-000004 / 322000-000015 )
- Serial Port ( 14Pin 1xRS232/RS422,RS485 / 20Pin 2xRS232 ) Cable x1 ( 32200-000063 / 32200-000003 )
- Audio Cable x1 ( 32000-000035 )
- VGA Cable x1 ( 32000-000028 )
- IEEE1394 Cable x1 ( NOVA-7896FW Only ) ( 32000-021900 )

# 2

## Installation

This chapter describes how to install the NOVA-7896/7896FW. The layout of NOVA-7896/7896FW is shown on the next page and the Unpacking Precautions that you should be careful with are described on the following page. Also included is the jumpers and switches setting for this board's configuration, such as: CPU type selection, system clock setting and Watchdog timer.

### 2.1 NOVA-7896/7896FW 's Layout

< please, refer to the next page >

### 2.1 NOVA-7896/7896FW 's Layout

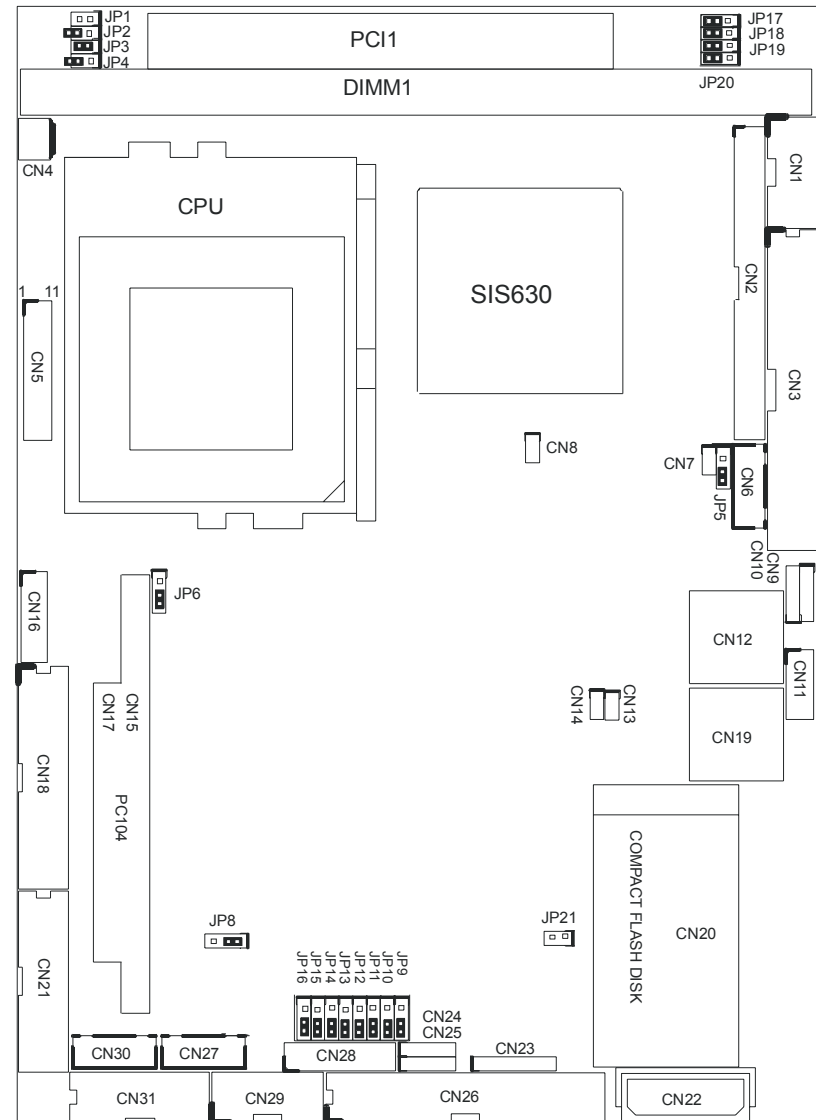

## .2 NOVA-7896/7896FW 's Dimension ( Unit : mm )

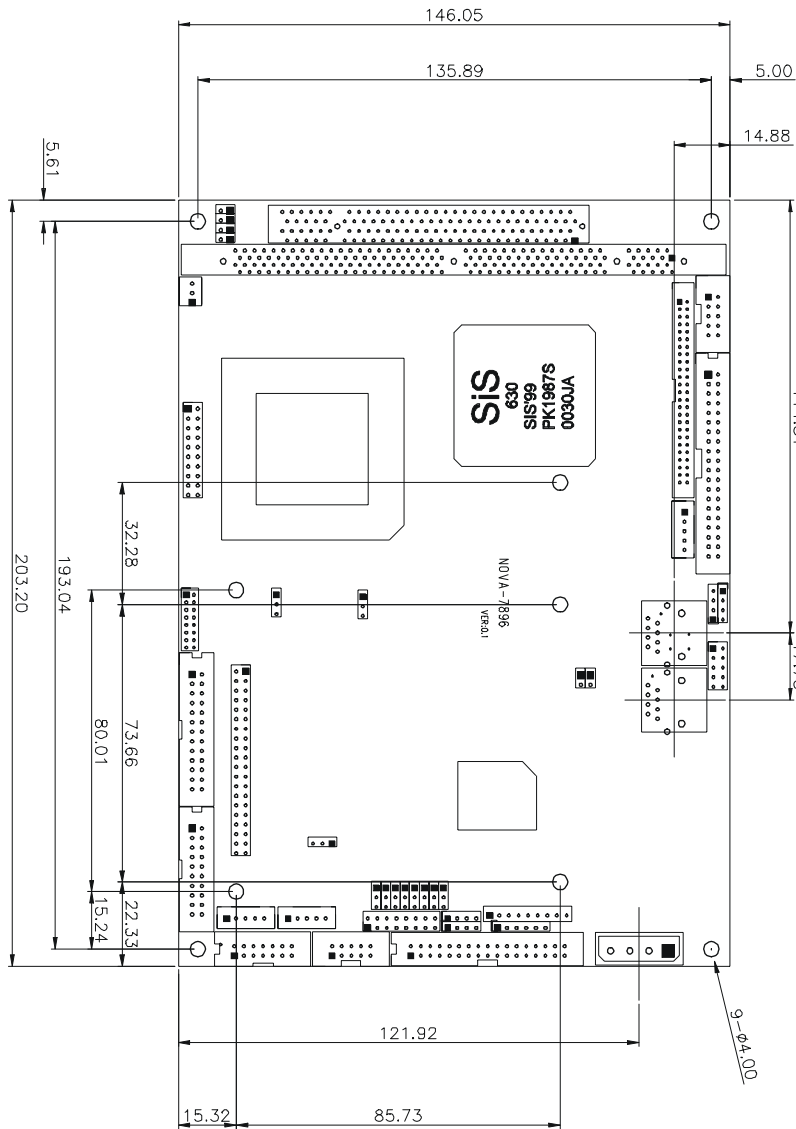

## 2.3 Unpacking Precautions

Some components on NOVA-7896/7896FW are very sensitive to static electric charges and can be damaged by a sudden rush of power. To protect it from unintended damage, be sure to follow these precautions:

- ✓ Ground yourself to remove any static charge before touching your NOVA-7896/7896FW. You can do it by using a grounded wrist strap at all times or by frequently touching any conducting materials that is connected to the ground.
- ✓ Handle your NOVA-7896/7896FW by its edges. Don't touch IC chips, leads or circuitry if not necessary.
- ✓ Do not plug any connector or jumper while the power is on.
- ✓ Do not put your NOVA-7896/7896FW unprotected on a flat surface because it has components on both sides.

## 2.4 Setting the CPU of NOVA-7896/7896FW

- JP1,2,3,4 : CPU & DRAM FREQUENCY SETTING ( H/W )



CPU/DRAM	JP1	JP2	JP3	JP4
66/66	C	O	O	O
100/100	O	O	C	O
133/133	O	C	C	C

O : Open  
C : Close

## 2.5 Clear CMOS Setup

If you forget the CMOS password, you can clear or reset it by closing the **JP6**. After JP6(1-2) is closed, turn on the power for about 3 seconds then turn it off and open the JP6(1-2). Now, the password has been cleared from your CMOS.

- **JP6 : Clear CMOS Setup**



PIN NO.	DESCRIPTION
2-3	Normal Operation
1-2	Clear CMOS Setup

## 2.6 COM2 RS-232/422,485 Selection

- **JP8 : COM2 Mode Selection**



JP8	DESCRIPTION
1-2	RS232
2-3	RS422/RS485

\*\* 2-3 RS422 / RS485 ( Option )

## 2.7 COM Port RI and Voltage Selection

- **JP16,JP15: Set pin 9 of COM1 as signal RI or voltage source**



JP16	DESCRIPTION
2-3	COM1 RI Pin Use RI
1-2	COM1 RI Pin Use Voltage

JP15	DESCRIPTION
2-3	COM1 RI Pin Use Voltage +12V
1-2	COM1 RI Pin Use Voltage +5V

\* If JP16 Uses ( 2-3 ) Don't care JP15



- **JP14,JP13:** Set pin 9 of COM2 as signal RI or voltage source



JP14	DESCRIPTION
2-3	COM2 RI Pin Use RI
1-2	COM2 RI Pin Use Voltage

JP13	DESCRIPTION
2-3	COM2 RI Pin Use Voltage +12V
1-2	COM2 RI Pin Use Voltage +5V

\* If JP14 Uses ( 2-3 ) Don't care JP13

- **JP11,JP12:**Set pin 9 of COM3 as signal RI or voltage source



JP11	DESCRIPTION
2-3	COM3 RI Pin Use RI
1-2	COM3RI Pin Use Voltage

JP12	DESCRIPTION
2-3	COM3 RI Pin Use Voltage +12V
1-2	COM3RI Pin Use Voltage +5V

\* If JP11 Uses ( 2-3 ) Don't care JP12

- **JP9,JP10:** Set pin 9 of COM4 as signal RI or voltage source



JP9	DESCRIPTION
2-3	COM4 RI Pin Use RI
1-2	COM4RI Pin Use Voltage

JP10	DESCRIPTION
2-3	COM4 RI Pin Use Voltage +12V
1-2	COM4RI Pin Use Voltage +5V

\* If JP9 Uses ( 2-3 ) Don't care JP10

## 2.8 LCD Panel power Setup

To set the operating voltage for the LCD Panel.

- **JP5 : LCD Power Setting**



JP5	DESCRIPTION
2-3	+3.3V
1-2	+5V

\* Set to +5V is NOT standard

PIN NO.	DESCRIPTION
Open	Slave
Short	Master

## 2.9 LCD Panel Type Selection

NOVA-7896/7896FW can support up to 24 bit LCD.

- **JP17,18,19,20 : LCD Panel Type Selection ( H/W )**

Now support LCD Type:

1. IMES M121-SOHR ( 800x600 TFT)
2. LG LM151X2 ( 1024x768 TFT )
3. SAMSUNG LT121S1-153 ( 800x600 TFT )
4. SAMSUNG LT121S1-106 ( 800x600 TFT )

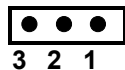

JP17	JP18	JP19	JP20	DESCRIPTION
2-3	2-3	1-2	2-3	1024X768 TFT
2-3	2-3	2-3	2-3	800X600 TFT

## 2.10 CompactFlash™ Disk Setting

The CompactFlash™ Disk is 100% compatible to IDE hard disk. It is just “plug and play”, easy and reliable. The CompactFlash™ Disk is available from 128MB to 1GB. Besides it can accept type II IBM MicroDriver .

- **JP21: CompactFlash™ Disk IDE Master & Slave Setting**



# 3

## Connection

This chapter describes how to connect peripherals, switches and indicators to the NOVA-7896/7896FW board.

### 3.1 Floppy Disk Drive Connector

NOVA-7896/7896FW board is equipped with a 34-pin daisy-chain driver connector cable.

- **CN26 : FDD CONNECTOR**

PIN NO.	DESCRIPTION	PIN NO.	DESCRIPTION
1	GROUND	2	REDUCE WRITE
3	GROUND	4	N/C
5	GROUND	6	N/C
7	GROUND	8	INDEX#
9	GROUND	10	MOTOR ENABLE A#
11	GROUND	12	DRIVE SELECT B#
13	GROUND	14	DRIVE SELECT A#
15	GROUND	16	MOTOR ENABLE B#
17	GROUND	18	D4IRECTION#
19	GROUND	20	STEP#
21	GROUND	22	WRITE DATA#
23	GROUND	24	WRITE GATE#
25	GROUND	26	TRACK 0#

27	GROUND	28	WRITE PROTECT#
29	GROUND	30	READ DATA#
31	GROUND	32	SIDE 1 SELECT#
33	GROUND	34	DISK CHANGE#

### 3.2 PCI E-IDE Disk Drive Connector

You can attach two IDE (Integrated Device Electronics) hard disk drives to the NOVA-7896/7896FW IDE controller. The maximal data transfer rate is 66M B/s . In this case ,cable total length shall not exceed 0.46 m ( 18in ).

#### CN3 ( 40Pin 2.54mm IDE) : Primary IDE Connector

##### • CN3 : IDE Interface Connector

PIN NO.	DESCRIPTION	PIN NO.	DESCRIPTION
1	RESET#	2	GND
3	DATA 7	4	DATA 8
5	DATA 6	6	DATA 9
7	DATA 5	8	DATA 10
9	DATA 4	10	DATA 11
11	DATA 3	12	DATA 12
13	DATA 2	14	DATA 13
15	DATA 1	16	DATA 14
17	DATA 0	18	DATA 15
19	GND	20	N/C
21	IDE DRQ	22	GND
23	IOW#	24	GND
25	IOR#	26	GND
27	IDE CHRDY	28	GND
29	IDE DACK	30	GND
31	INTERRUPT	32	N/C
33	SA 1	34	N/C
35	SA 0	36	SA 2
37	HDC CS0#	38	HDC CS1#
39	HDD ACTIVE#	40	GND

### 3.3 Parallel Port

This port is usually connected to a printer, The NOVA-7896/7896FW includes an on-board parallel port, accessed through a 26-pin flat-cable connector CN18.

• **CN18 : ( LPT1 ) Parallel Port Connector**

Pin	Description	Pin	Description
1	STROBE#	2	AUTO FORM FEED #
3	DATA 0	4	ERROR#
5	DATA 1	6	INITIALIZE
7	DATA 2	8	PRINTER SELECT LN#
9	DATA 3	10	GND
11	DATA 4	12	GND
13	DATA 5	14	GND
15	DATA 6	16	GND
17	DATA 7	18	GND
19	ACKNOWLEDGE	20	GND
21	BUSY	22	GND
23	PAPER EMPTY	24	GND
25	PRINTER SELECT	26	N/C

• **CN31 : Serial Port 2x7 pin header Connector (COM2)**

**COM2 Support Three Mode : RS232, RS422/RS485  
( For 2x7 pin header Connector )**

**RS232 Mode**

Pin No.	Description	Pin No.	Description
1	DCD	2	DSR
3	RXD	4	RTS
5	TXD	6	CTX
7	DTR	8	RI
9	GND	10	NC

**RS422 / RS485 Mode ( Option )**

**( For 2x7 pin header Connector )**

**RS422 Mode**

Pin No.	Description	Pin No.	Description
1		2	
3		4	
5		6	
7		8	
9		10	
11	TX+	12	TX-
13	RX+	14	RX-

**( For 2x7 pin header Connector )**

**RS485 Mode**

Pin No.	Description	Pin No.	Description
1		2	
3		4	
5		6	
7		8	
9		10	
11	TX+	12	TX-
13		14	

### 3.4 Serial Ports

The NOVA-7896/7896FW offers four high speed NS16C550 compatible UARTs with Read/Receive 16 byte FIFO serial ports (COM1/COM2/COM3/COM4).

• **CN29 : Serial Port 2x5 pin header Connector (COM1)**

Pin No.	Description	Pin No.	Description
1	DCD	2	DSR
3	RXD	4	RTS
5	TXD	6	CTX
7	DTR	8	RI
9	GND	10	NC

5	+5V
---	-----

- **CN21 : Serial Port 2x10 pin header Connector (COM3 / 4)**  
 ( For 2x10 pin header Connector )  
**COM3 : CN21 PIN 1 - 10**  
**COM4 : CN21 PIN 11 – 20**

Pin No.	Description	Pin No.	Description
1	DCD3	2	DSR3
3	RXD3	4	RTS3
5	TXD3	6	CTX3
7	DTR3	8	RI3
9	GND	10	N/C
11	DCD4	12	DSR4
13	RXD4	14	RTS4
15	TXD4	16	CTX4
17	DTR4	18	RI4
19	GND	20	N/C

### 3.5 Keyboard/Mouse Connector

The NOVA-7896/7896FW provides one internal one mouse and one keyboard connectors.

- **CN27 : 5-pin Header Mouse Connector**

PIN NO.	DESCRIPTION
1	MS DATA
2	N/C
3	GND
4	VCC
5	MS CLOCK

- **CN30 : 5-pin Header Keyboard Connector**

PIN NO.	DESCRIPTION
1	KB CLOCK
2	KB DATA
3	N/C
4	GND

### 3.6 External Switches and Indicators

There are several external switches and indicators for monitoring and controlling your CPU board. All the functions are in the CN5 connector.

- **CN5 : Multi Panel**

PIN NO.	DESCRIPTION	PIN NO.	DESCRIPTION
1.	SPEAKER	11	POWER-LED +
2.	N/C	12	N/C
3.	N/C	13	POWER-LED -
4.	SPEAKER +5V	14	KEYLOCK+
5.	RESET SW	15	KEYLOCK -
6.	RESET SW GND	16	GND
7.	IDE LED -	17	N/C
8.	IDE LED+	18	ATX POWER PSON#
9.	ATX POWER BUTTON	19	ATX 5VSB
10.	ATX POWER BUTTON GND	20	ATX 5VSB

### 3.7 USB Port Connector

The NOVA-7896/7896FW has two built-in USB ports for the future new I/O bus expansion.

- **CN9,10: Pin Header USB Connectors**

PIN NO.	Description
1	VCC
2	USB0-
3	USB0+
4	GND

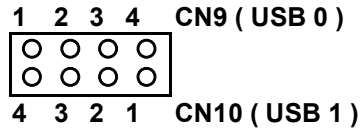

### 3.8 IrDA Infrared Interface Port

NOVA-7896/7896FW built-in IrDA port supports Serial Infrared (SIR) or Amplitude Shift Keyed IR (ASKIR) interface. If you want to use the IrDA port, you have to configure the FIR or ASKIR model in the BIOS's Peripheral Setup's COM2. Then the normal RS-232 COM2 will be disabled.

- **CN23 : IrDA Connector**

PIN NO.	DESCRIPTION
1	VCC
2	N/C
3	IR-RX
4	GND
5	IR-TX

### 3.9 VGA Connector

The built-in 10-pin Header VGA connector can be connected directly to your monochrome CRT monitor as well as high resolution color CRT monitor.

- **CN1 : 10-pin Header VGA Connector**

1	RED	2	SMDATA
3	GREEN	4	SMCLK
5	BLUE	6	GND
7	H-SYNC	8	GND
9	V-SYNC	10	GND

### 3.10 LAN RJ45 Connector

NOVA-7896/7896FW Socket 370 Celeron™ & Pentium III®  
Multimedia & Dual Ethernet ,IEEE1394, Embedded Board

NOVA-7896/7896FW is equipped with two 10/100Mbps Ethernet Controller. You can connect it to your LAN through RJ45 connector. The pin assignments are as follows.

- **CN12,19 : LAN RJ45 Connector**

1	TX+	5.	N/C
2	TX-	6.	RX-
3.	RX+	7.	N/C
4.	N/C	8.	N/C

CN12 : On chip SIS 900 LAN

CN19 : PCI BUS Realtek 8139C LAN

- **CN7 : Active LED Connector For on chip SIS900 LAN**

Pin No.	Description	Pin No.	Description
1	LAN ACT.	2	VCC

- **On Chip SIS900 LAN Support Active LED Only**

- **CN14 : Active LED Connector For Realtek 8139C LAN**

Pin No.	Description	Pin No.	Description
1	VCC	2	LAN ACT.

- **CN13 : Link LED Connector For Realtek 8139C LAN**

Pin No.	Description	Pin No.	Description
1	VCC	2	LAN Link

### 3.11 Fan Connector

The NOVA-7896/7896FW provides one CPU cooling fan connector and one system fan connectors. These connectors can supply 12V/500mA to the cooling fan.

NOVA-7896/7896FW Socket 370 Celeron™ & Pentium III®  
Multimedia & Dual Ethernet ,IEEE1394, Embedded Board

• **CN4 : CPU Fan Connector**

PIN NO.	DESCRIPTION
1	GND
2	+12V
3	Fan Sensor

### 3.12 Temperature Sensor Connector

You can connect external temperature sensor to this connector.

• **CN8 : Temperature Sensor Connector**

**\*\* Use 10K Ohm Temperature register sensor**

Pin No.	Description	Pin No.	Description
1	THER-DA	2	GND

### 3.13 Audio CD IN

This is used to connect to the CD-Out from CD-ROM player.

• **CN25 : Audio CD IN ( 2.54mm )**

Pin No.	Description	Pin No.	Description
1	CD IN_R	2	GND
3	GND	4	CD IN_L

### 3.14 Audio Speaker OUT ( Reserved )

• **CN24 : Left/Right Audio SPK Output Connector**

**By optional amplifier Speaker Output .  
(Two 6W stereo power amplifiers )**

1.	( SPK Right Out)
2.	GND
3.	GND
4.	( SPK Left Out)

### 3.15 Audio Panel

One line-out ( 2 different pin assignments ),one line-in and one mic-in are supported. All these output are from audio chip without being amplified.

• **CN28 : Audio Panel**

Pin	Description	Pin	Description
1	Line Out R	2	GND
3	Line Out L	4	GND
5	Line Out R	6	Line Out L
7	GND	8	GND
9	Line In R	10	Line In L
11	GND	12	GND
13	NC	14	NC
15	MIC In	16	GND

### 3.16 CompactFlash Storage Card Socket

The NOVA-7896/7896FW configures CompactFlash Storage Card in IDE Mode.  
It will use IDE Secondary / Slave channel when CompactFlash card is plugged in.

• **CN20 : CompactFlash Storage Card Socket pin assignment**

PIN NO	DESCRIPTION	PIN NO	DESCRIPTION
1	GROUND	26	CARD DETECT1
2	D3	27	D11
3	D4	28	D12
4	D5	29	D13
5	D6	30	D14
6	D7	31	D15
7	CS1#	32	CS3#
8	N/C	33	N/C

9	GROUND	34	IOR#
10	N/C	35	IOW#
11	N/C	36	OBLIGATORY TO PULL HIGH
12	N/C	37	IRQ15
13	VCC	38	VCC
14	N/C	39	MASTER/SLAVE
15	N/C	40	N/C
16	N/C	41	RESET#
17	N/C	42	IRDY
18	A2	43	N/C
19	A1	44	OBLIGATORY TO PULL HIGH
20	A0	45	ACTIVE#
21	D0	46	PDIAG#
22	D1	47	D8
23	D2	48	D9
24	N/C	49	D10
25	CARD DETECT2	50	GROUND

### 3.17 Power Connector

The NOVA-7896/7896FW can work without back-plane , while attaching external power to this connector .

- **CN22: Power Supply Connector**

1.	+5V
2.	GND
3.	GND
4.	+12V

### 3.18 LCD Backlight Connector

- **CN6 : LCD Backlight Connector**

Pin No.	Description	Pin No.	Description
1	NC	2	ENABKL
3	GND	4	+12V
5	GND		

### 3.19 Digital Input / Output

NOVA-7896/7896FW provides you with an isolated digital input/output. The usage will be explained in detail in appendix G.

- **CN11 : Digital Input / Output**

Pin	Description	Pin	Description
1	Input 0	2	Input 1
3	Input 2	4	Input 3
5	Output 0	6	Output 1
7	Output 2	8	Output 3
9	Ext-GND	10	Ext-VCC

### 3.20 LCD Panel Connector

- **CN2 : LCD Panel Connector**

Pin	Description	Pin	Description
1	NC	2	NC
3	NC	4	NC
5	NC	6	NC
7	NC	8	NC
9	NC	10	NC
11	NC	12	NC
13	NC	14	P21
15	P23	16	P22
17	P16	18	P20
19	P17	20	P18
21	P19	22	P14
23	P13	24	P12



25	P15	26	P11
27	P7	28	P10
29	VDD	30	VDD
31	P9	32	P8
33	P4	34	P6
35	P3	36	P5
37	P2	38	P1
39	M	40	P0
41	SHFCLK	42	ENABLK
43	FPVDD	44	FLM
45	FPVEE	46	LP
47	GND	48	GND
49	+12V	50	+12V

# 4

## 3.21 IEEE1394 Connector

### • CN16 : IEEE1394 Connector

Pin	Description	Pin	Description
1	+12 VCC	9	+12 VCC
2	GND	10	GND
3	TPB1-	11	TPB0-
4	TPB1+	12	TPB0+
5	TPA1-	13	TPA0-
6	TPA1+	14	TPA0+
7	CASE	15	CASE
8	CASE	16	CASE

## AWARD BIOS SETUP

### 4.1 Introduction

This manual discusses Award's Setup program built into the ROM BIOS. The Setup program allows users to modify the basic system configuration. This special information is then stored in battery-backed RAM so that it retains the Setup information when the power is turned off.

### 4.2 Starting Setup

The Award BIOS is immediately activated when you first power on the computer. The BIOS reads the system information contained in the CMOS and begins the process of checking out the system and configuring it. When it finishes, the BIOS will seek an operating system on one of the disks and then launch and turn control over to the operating system.

While the BIOS is in control, the Setup program can be activated in one of two ways:

1. By pressing <Del> immediately after switching the system on, or
2. by pressing the <Del> key when the following message appears briefly at the bottom of the screen during the POST (Power On Self Test).

**Press DEL to enter SETUP.**

If the message disappears before you respond and you still wish to enter Setup, restart the system to try again by turning it OFF then ON or pressing the "RESET" button on the system case. You may also restart by simultaneously pressing <Ctrl>, <Alt>, and <Delete> keys. If you do not press the keys at the correct time and the system does not boot, an error message will be displayed and you will again be asked to...

**PRESS F1 TO CONTINUE, DEL TO ENTER SETUP**

**Using Setup**

In general, you use the arrow keys to highlight items, press <Enter> to select, use the PageUp and PageDown keys to change entries, press <F1> for help and press <Esc> to quit. The following table provides more detail about how to navigate in the Setup program using the keyboard.

Up arrow	Move to previous item
Down arrow	Move to next item
Left arrow	Move to the item in the left hand
Right arrow	Move to the item in the right hand
Esc key	Main Menu -- Quit and not save changes into CMOS Status Page Setup Menu and Option Page Setup Menu -- Exit current page and return to Main Menu
PgUp key	Increase the numeric value or make changes
PgDn key	Decrease the numeric value or make changes
+ key	Increase the numeric value or make changes
- key	Decrease the numeric value or make changes
F1 key	General help, only for Status Page Setup Menu and Option Page Setup Menu
(Shift)F2 key	Change color from total 16 colors. F2 to select color forward, (Shift) F2 to select color backward
F3 key	Cancel, only for Status Page Setup Menu
F4 key	Reserved
F5 key	Restore the previous CMOS value from CMOS, only for Option Page Setup Menu

F6 key	Load the default CMOS value from BIOS default table, only for Option Page Setup Menu
F7 key	Load the default
F8 key	Reserved
F9 key	Reserved
F10 key	Save all the CMOS changes, only for Main Menu

**4.4 Getting Help**

Press F1 to pop up a small help window that describes the appropriate keys to use and the possible selections for the highlighted item. To exit the Help Window press <Esc> or the **F1** key again.

If, after making and saving system changes with Setup, you discover that your computer no longer is able to boot, the Award BIOS supports an override to the CMOS settings which resets your system to its defaults. The best advice is to only alter settings which you thoroughly understand. To this end, we strongly recommend that you avoid making any changes to the chipset defaults. These defaults have been carefully chosen by both Award and your systems manufacturer to provide the absolute maximum performance and reliability. Even a seemingly small change to the chipset setup has the potential for causing you to use the override.

## 4.5 Main Menu

Once you enter the AwardBIOS™ CMOS Setup Utility, the Main Menu will appear on the screen. The Main Menu allows you to select from several setup functions and two exit choices. Use the arrow keys to select among the items and press <Enter> to accept and enter the sub-menu.

CMOS Setup Utility - Copyright ( C ) 1984-1998

Standard CMOS Feature	Frequency/Voltage Control
Advanced BIOS Feature	Load Fail-Safe Defaults
Advanced Chipset Feature	Load Optimized Defaults
Integrated Peripherals	Set Supervisor Password
Power Management Setup	Set User Password
PnP/PCI Configurations	Save & Exit Setup
PC Health Status	Exit Without Saving
Esc : Quit ↑↓←→ : Select Item	
F10 : Save & Exit Setup	
Time, Date, Hard Disk Type....	

Note that a brief description of each highlighted selection appears at the bottom of the screen.

The main menu includes the following main setup categories. Recall that some systems may not include all entries.

---

### Standard CMOS Features

Use this menu for basic system configuration. See Section 4.6 for the details.

---

### Advanced BIOS Features

Use this menu to set the Advanced Features available on your system. See Section 4.7 for the details.

---

### Advanced Chipset Features

Use this menu to change the values in the chipset registers and optimize your system's performance. See section 4.8 for the details.

---

### Integrated Peripherals

Use this menu to specify your settings for integrated peripherals. See section 4.9 for the details.

---

### Power Management Setup

Use this menu to specify your settings for power management. See section 4.10 for the details.

---

### PnP / PCI Configuration

This entry appears if your system supports PnP / PCI. See section 4.11 for the details.

---

### PC Health Status

Use this menu to monitor your hardware. See section 4.12 for the details.

---

### Frequency/Voltage Control

Use this menu to specify your settings for frequency/voltage control. See section 4.13 for the details.

---

### **Load Fail-Safe Defaults**

Use this menu to load the BIOS default values for the minimal/stable performance for your system to operate. See section 4.14 for the details.

---

### **Load Optimized Defaults**

Use this menu to load the BIOS default values that are factory settings for optimal performance system operations. While Award has designed the custom BIOS to maximize performance, the factory has the right to change these defaults to meet their needs. See section 4.14 for the details.

---

### **Supervisor / User Password**

Use this menu to set User and Supervisor Passwords. See section 4.15 for the details.

---

### **Save & Exit Setup**

Save CMOS value changes to CMOS and exit setup. See section 4.16 for the details.

---

### **Exit Without Save**

Abandon all CMOS value changes and exit setup. See section 4.16 for the details.

## **4.6 Standard CMOS Setup**

The items in Standard CMOS Setup Menu are divided into 10 categories. Each category includes no, one or more than one setup items. Use the arrow keys to highlight the item and then use the <PgUp> or <PgDn> keys to select the value you want in each item.

Standard CMOS Features

Date: Mon, Feb 8 1999 Time: 16:19:20	Item Help
<ul style="list-style-type: none"> <li>➤ IDE Primary Master 2557 MB</li> <li>➤ IDE Primary Slave None</li> <li>➤ IDE Secondary Master None</li> <li>➤ IDE Secondary Slave None</li> </ul> <p>Drive A 1.44M, 3.5 in. Drive B None</p> <p>LCD&amp;CRT Both Panel : Hardware Setting</p> <p>Halt On All Errors</p> <p>Based Memory 640K Extended Memory 64512K Total Memory 65536K</p>	<p>Menu Level ➤</p> <p>Change the day, month, year and century</p>
<p>↑↓←→Move Enter: Select +/-/PU/PD: Value F10:Save ESC: Exit F1:General Help F5:Previous Values F6:Fail-safe defaults F7:Optimized Defaults</p>	

Figure 1: The Main Menu

### Main Menu Selections

Item	Options	Description
Date	MM DD YYYY	Set the system date.
Time	HH : MM : SS	Set the system time
IDE Primary Master	Options are in its sub menu (described in Table 3)	Press <Enter> to enter the sub menu of detailed options

IDE Primary Slave	Options are in its sub menu (described in Table 3)	Press <Enter> to enter the sub menu of detailed options
IDE Secondary	Options are in its sub menu (described in Table 3)	Press <Enter> to enter the sub menu of detailed options
IDE Secondary	Options are in its sub menu (described in Table 3)	Press <Enter> to enter the sub menu of detailed options
Drive A Drive B	None 360K, 5.25 in 1.2M, 5.25 in 720K, 3.5 in 1.44M, 3.5 in 2.88M, 3.5 in	Select the type of floppy disk drive installed in your system
LCD&CRT	Both CRT	Select LCD & CRT Display
Panel	Hardware Setting 800x600 TFT1 800x600 TFT2 1024x768 18bit TFT1 1024x768 18bit TFT2 1024x768 18bit TFT3 1024x768 18bit TFT4 1024x768 24bit TFT	Select Panel Type. Every type is predefined with a special timing. You may try each setting according to your LCD. However, not every kind of LCD will be supported.
Halt On	All Errors No Errors All, but Keyboard All, but Diskette All, but Disk/Key	Select the situation in which you want the BIOS to stop the POST process and notify you
Base Memory	N/A	Displays the amount of conventional memory detected during boot up
Extended Memory	N/A	Displays the amount of extended memory detected during boot up
Total Memory	N/A	Displays the total memory available in the system

Table 2 Main Menu Selections

## IDE Adapters

The IDE adapters control the hard disk drive. Use a separate sub menu to configure each hard disk drive.

Figure 2 shows the IDE primary master sub menu.

CMOS Setup Utility – Copyright © 1984-1998 Award Software  
IDE Primary Master

IDE HDD Auto-Detection	Press Enter	Item Help
IDE Primary Master	Auto 2557 MB	Menu Level >>
Access Mode	Auto	
Cylinder	4956	To auto-detect the HDD's size, head... on this channel
Head	16	
Precomp	0	
Landing Zone	4955	
Sector	63	
↑↓←→Move Enter: Select +/-/PU/PD: Value F10:Save ESC: Exit F1:General Help F5:Previous Values F6:Fail-safe defaults F7:Optimized Defaults		

Figure 2 IDE Primary Master sub menu

Use the legend keys to navigate through this menu and exit to the main menu. Use Table 3 to configure the hard disk.

Item	Options	Description
IDE HDD Auto-detection	Press Enter	Press Enter to auto-detect the HDD on this channel. If detection is successful, it fills the remaining fields on this menu.
IDE Primary Master	None	Selecting 'manual' lets you

	Auto Manual	set the remaining fields on this screen. Selects the type of fixed disk. "User Type" will let you select the number of cylinders, heads, etc. Note: PRECOMP=65535 means NONE !
Capacity	Auto Display your disk drive size	Disk drive capacity (Approximated). Note that this size is usually slightly greater than the size of a formatted disk given by a disk checking program.
Access Mode	Normal LBA Large Auto	Choose the access mode for this hard disk
The following options are selectable only if the 'IDE Primary Master' item is set to 'Manual'		
Cylinder	Min = 0 Max = 65535	Set the number of cylinders for this hard disk.
Head	Min = 0 Max = 255	Set the number of read/write heads
Precomp	Min = 0 Max = 65535	**** <b>Warning:</b> Setting a value of 65535 means no hard disk
Landing zone	Min = 0 Max = 65535	****
Sector	Min = 0 Max = 255	Number of sectors per track

Table 3 Hard disk selections

## 4.7 Advanced BIOS Features

This section allows you to configure your system for basic operation. You have the opportunity to select the system's default speed, boot-up sequence, keyboard operation, shadowing and security.

CMOS Setup Utility – Copyright © 1984 – 1998 Award Software  
Advanced BIOS Features

Virus Warning	Enabled	Item Help
CPU Internal Cache	Enabled	
External Cache	Enabled	
CPU L2 Cache ECC Checking	Enabled	
Quick Power On Self Test	Disabled	Menu Level >
First Boot device	Floppy	
Second Boot device	HDD-0	Allows you to choose the
Third Boot device	Floppy	VIRUS warning feature for
Boot other device	Disabled	IDE Hard Disk boot sector
Swap Floppy Drive	Disabled	protection. If this function is
		enabled and someone
Boot Up Floppy Seek	Disabled	attempt to write data into this
Boot Up NumLock Status	Off	area, BIOS will show a
Gate A20 Option	Normal	warning message on screen
Typematic Rate Setting	Disabled	and alarm beep
Typematic Rate (Chars/Sec)	6	
Typematic Delay (Msec)	250	
Security Option	Setup	
OS Select For DRAM > 64MB	Non-OS2	
Report NO FDD For Win 95	No	
↑↓←→Move Enter: Select +/-/PU/PD: Value F10:Save ESC: Exit F1:General Help F5:Previous Values F6:Fail-safe defaults F7:Optimized Defaults		

Allows you to choose the VIRUS Warning feature for IDE Hard Disk boot sector protection. If this function is enabled and someone attempt to write data into this area, BIOS will show a warning message on screen and alarm beep.

Enabled	Activates automatically when the system boots up causing a warning message to appear when anything attempts to access the boot sector or hard disk partition table.
Disabled	No warning message will appear when anything attempts to access the boot sector or hard disk partition table.

### CPU Internal Cache/External Cache

These two categories speed up memory access. However, it depends on CPU/chipset design.

Enabled	Enable cache
Disabled	Disable cache

### CPU L2 Cache ECC Checking

This item allows you to enable/disable CPU L2 Cache ECC checking. The choice: Enabled, Disabled.

### Processor Number Feature

Some of the new generation of socket-370 processors are installed with a unique processor number. This number may be used for verification in internet transactions and e-commerce. If you prefer not to use or distribute the unique processor number, use this item to suppress the processor number. The Choice : Enable, Disable.

### Virus Warning

### Quick Power On Self Test

This category speeds up Power On Self Test (POST) after you power up the computer. If it is set to Enable, BIOS will shorten or skip some check items during POST.

Enabled	Enable quick POST
Disabled	Normal POST

---

### First/Second/Third/Other Boot Device

The BIOS attempts to load the operating system from the devices in the sequence selected in these items.  
The Choice: Floppy, LS/ZIP, HDD, SCSI, CDROM, Disabled.

---

### Swap Floppy Drive

If the system has two floppy drives, you can swap the logical drive name assignments.

The choice: Enabled/Disabled.

---

### Boot Up Floppy Seek

Seeks disk drives during boot up. Disabling speeds boot up.

The choice: Enabled/Disabled.

---

### Boot Up NumLock Status

Select power on state for NumLock.  
The choice: Enabled/Disabled.

---

### Gate A20 Option

Select if chipset or keyboard controller should control GateA20.

Normal	A pin in the keyboard controller controls GateA20
Fast	Lets chipset control GateA20

---

### Typematic Rate Setting

Key strokes repeat at a rate determined by the keyboard controller. When enabled, the typematic rate and typematic delay can be selected. The choice: Enabled/Disabled.

---

### Typematic Rate (Chars/Sec)

Sets the number of times a second to repeat a key stroke when you hold the key down.  
The choice: 6, 8, 10, 12, 15, 20, 24, 30.

---

### Typematic Delay (Msec)

Sets the delay time after the key is held down before it begins to repeat the keystroke.  
The choice: 250, 500, 750, 1000.

---

### Security Option

Select whether the password is required every time the system boots or only when you enter setup.

System	The system will not boot and access to Setup will be denied if the correct password is not entered at the prompt.
Setup	The system will boot, but access to Setup will be denied if the correct password is not entered at the prompt.

Note: To disable security, select PASSWORD SETTING at Main Menu and then you will be asked to enter password. Do not type anything and just press <Enter>, it will disable security. Once the security is disabled, the system will boot and you can enter Setup freely.

---

### OS Select For DRAM > 64MB

Select the operating system that is running with greater than 64MB of RAM on the system.

The choice: Non-OS2, OS2.

---

### Report No FDD For Win 95



Whether report no FDD for Win 95 or not.

The choice: Yes, No.

---

### Video BIOS Shadow

This item allows the video BIOS to be copied to system memory for faster performance.

The Choice : Enable , Disable.

## 4.8 Advanced Chipset Features

CMOS Setup Utility – Copyright © 1984 – 1998 Award Software  
Advanced Chipset Features

	Press	Item Help
Advanced DRAM Control 1	Press	
Advanced DRAM Control 2	Press	
Enter		
System BIOS Cacheable	Disabled	Menu Level ➤
Video BIOS Cacheable	Disabled	
Memory Hole At 15M-16M	Enabled	
AGP Aperture Size	64MB	
Graphic Window WR Combin	Enable	
Concurrent function ( MEM )	Enabled	
Concurrent function ( PCI )	Enabled	
CPU Pipeline Control	Enabled	
PCI Delay Transaction	Enabled	
Power-supply Type	AT	
Memory Parity Check	Enabled	

↑↓←→Move Enter: Select +/-/PU/PD: Value F10:Save ESC: Exit  
F1:General Help  
F5:Previous Values F6:Fail-safe defaults F7:Optimized Defaults

This section allows you to configure the system based on the specific features of the installed chipset. This chipset manages bus speeds and access to system memory resources, such as DRAM and the external cache. It also coordinates communications between the conventional ISA bus and the PCI bus. It must be stated that these items should never need to be altered. The default settings have been chosen because they provide the best operating conditions for your system.

---

### Advanced DRAM Control 1 / 2 Settings

The first chipset settings deal with CPU access to dynamic random access memory (DRAM). The default timings have been carefully chosen and should only be altered if data is being lost. Such a scenario might well occur if your system had mixed speed DRAM chips installed

so that greater delays may be required to preserve the integrity of the data held in the slower memory chips.

---

### Auto Configuration

This item will automatically configure the chipset timing. . You may select 'manual' to set up following gray items by your specific need.

The choice: Manual, Auto, 100MHZ, 133MHZ.

---

### SDRAM RAS Active Time

This item defines SDRAM ACT to PRE command period.

The Choice: 6T, 7T, 5T, 4T.

---

### SDRAM RAS Precharge Time

This item defines SDRAM PRE to ACT command period.

The Choice: 3T, 2T, 4T, Reserved.

---

### RAS to CAS Delay

This item defines SDRAM ACT to Read/Write command period.

The choice: 3T, 2T, 4T, Reserved.

---

### Dram Background Command

This item is lead-off time control for DRAM background command. When select 'Delay 1T' , background commands are issued 1 clock behind memory address (MA) been issued. When select 'Normal', background command and MA are issued at the same time.

The choice: Delay 1T, Normal.

---

### LD-Off Dram RD/WR Cycles

The item is lead-off time control for DRAM Read/Write Cycles. When select 'Delay 1T' , memory read/write command is issued 1 clock behind memory address (MA) been issued. When select 'Normal', read/write command amd MA are issued at the same time.

The choice: Delay 1T, Normal.

---

### Write Recovery Time

This item defines the Data-in to PRE command period.

The choice: 1T, 2T

---

### VCM REF To ACT/REF Delay

This item defines VCM REF to REF/ACT command period.

The choice: 10T, 9T.

---

### VCM ACCT To ACT/REF Delay

This item defines VCM ACT to ACT/REF command period.

The choice: 10T, 9T, 8T, Reserved.

---

### Early CKE Delay 1T Cntrl

When this item is enabled, CKE is driven out from flip-flop. It is used when system operates under low frequency and CKE delay adjustment method defined in the 'Early CKE Delay Adjustment' which can not meet setup time and hold time requirement.

The choice: Normal, Delay 1T.

---

### Early CKE Delay Adjust

This item controls the timing for CKE. Various delay options are provided to ensure that CKE can meet SDRAM setup time and hold time specification when CKE is driven out.

The Choice: 1ns, 2ns, 3ns, 4ns, 5ns, 6ns, 7ns, 8ns.

---

### Mem Command Output Time

This item is to control the timing to drive memory command onto memory bus.

The choice: Normal, Delay 1T.

---

### SDRAM/VCM CAS Latency

When synchronous DRAM is installed, the number of clock cycles of CAS latency depends on the DRAM timing.

The Choice: 2, 3 , SPD

---

### SDRCLK Control

This item controls the phase of SDRCLK that lags behind SDCLK.

The choice: Enabled, Disabled.

---

### SDWCLK Control CS#/CKE

This item controls the phase of SDWCLK used for chip set select signals pin that lags ahead SDCLK.

The choice: Enabled, Disabled.

---

### SDWCLK Control MA/SRAS

This item controls the phase of SDWCLK used for MA/ SRAS signals that lags ahead SDCLK.

The choice: +5.0ns~-2.5ns (Default 0.0ns)

---

### SDWCLK Control DQM/MD

This item controls the phase of SDWCLK used for DQM/MD signals that lags ahead SDCLK.

The choice: +5.0ns~-2.5ns (Default 0.0ns)

---

### EGMRCLK Control

This item controls the phase of EGMRCLK that lags behind SDCLK.

The choice: -1.0ns~+6.5ns (Default 0.0ns)

---

### EGMWCLK Control

This item controls the phase of EGMWCLK that lags ahead SDCLK.

The choice: +5.0ns~-2.5ns (Default 0.0ns)

---

### System BIOS Cacheable

Selecting *Enabled* allows caching of the system BIOS ROM at F0000h-FFFFFh, resulting in better system performance. However, if any program writes to this memory area, a system error may result.

The choice: Enabled, Disabled.

---

### Vedio RAM Cacheable

Select Enabled allows caching of the video RAM , resulting in better system performance. However, if any program writes to this memory area, a system error may result.

The choice: Enabled, Disabled.

---

### Memory Hole at 15M-16M

You can reserve this area of system memory for ISA adapter ROM. When this area is reserved, it cannot be cached. The user information of peripherals that need to use this area of system memory usually discusses their memory requirements.

The Choice: Enabled, Disabled.

---

### AGP Aperture Size

Select the size of Accelerated Graphics Port (AGP) aperture. The aperture is a portion of the PCI memory address range dedicated for graphics memory address space. Host cycles that hit the aperture range are forwarded to the AGP without any translation.

The Choice: 4M, 8M, 16M, 32M, 64M, 128M, 256M.

This item controls the power-supply type to AT or ATX.  
The choice: AT,ATX.

---

### Memory Parity Check

Enabled this item to test the boot-up memory. .

The choice: Enabled, Disabled.

---

### Memory Parity Check

Enabled this item to test the boot-up memory. .

The choice: Enabled, Disabled.

---

### Memory Parity Check

Enabled this item to test the boot-up memory. .

The choice: Enabled, Disabled.

---

### Memory Parity Check

Enabled this item to test the boot-up memory. .

The choice: Enabled, Disabled.

---

### Memory Parity Check

Enabled this item to test the boot-up memory. .

The choice: Enabled, Disabled.

---

### Memory Parity Check

Enabled this item to test the boot-up memory. .

The choice: Enabled, Disabled.

---

### Memory Parity Check

Enabled this item to test the boot-up memory. .

The choice: Enabled, Disabled.

---

### Memory Parity Check

Enabled this item to test the boot-up memory. .

The choice: Enabled, Disabled.

---

### Memory Parity Check

Enabled this item to test the boot-up memory. .

The choice: Enabled, Disabled.

---

### Graphic Window WR Combin

Use this item to enable or disable CPU support for WR Combin.

The Choice : Enable , Disable .

---

### Concurrent Function ( MEM )

This item is CPU & PCI Masters Concurrently Access Memory Function. Select enabled allows CPU access memory cycles and PCI masters access memory cycles concurrently issued onto host bus and PCI bus, respectively, and then the memory access cycles will be rearranged by SiS630 to memory sequentially.

The choice: Enabled, Disabled

---

### Concurrent Function ( PCI )

This item is CPU & PCI Masters Concurrently Access PCI Bus Function. Select enabled allows CPU access PCI bus cycle and PCI masters access memory cycles concurrently issued onto host bus and PCI bus, respectively.

The choice: Enabled, Disabled.

---

### CPU Pipeline Control

When enabled this item, only one pending cycle is allowed at one time. When disabled, there might be more than two pending cycles at one time depends on the CPU behaviour.

The choice: Enabled, Disabled.

---

### PCI Delay Transaction

If the chipset has an embedded 32-bit write buffer to support delay transaction cycles, you can enable this item to provide compliance with PCI Ver.2.1 specifications. We recommend that you leave this item at the default value.

The choice : Enable, Disable.

---

### Power-Supply Type

## 4.9 Integrated Peripherals

CMOS Setup Utility – Copyright © 1984 – 1998 Award Software  
Integrated Peripherals

SIS 630 OnChip IDE Device Press Enter		Item Help
SIS 630 OnChip PCI Device Press Enter		
Super I/O Device Press Enter		Menu Level ➤
USB Controller Enabled		If your IDE hard drive supports block mode select Enabled for automatic detection of the optimal number of block read/write per sector the drive can support
USB Keyboard Support Enabled		
Init Display First PCI Slot		
IDE HDD Block Mode Enabled		
System Share Memory 8MB		
↑↓←→ Move Enter: Select +/-/PU/PD: Value F10:Save ESC: Exit F1:General Help F5:Previous Values F6:Fail-safe defaults F7:Optimized Defaults		

### SIS 630 OnChip IDE Device

#### Internal PCI / IDE

This chipset contains an internal PCI IDE interface with support for two IDE channels. The choice: Primary, Secondary, Both.

#### IDE Primary Master/Slave PIO

The four IDE PIO (Programmed Input / Output) fields let you set a PIO mode (0-4) for each of the four IDE devices that the onboard IDE interface supports. Modes 0 through 4 provide successively increased performance. In *Auto* mode, the system automatically determines the best mode for each device.

The choice: Auto, Mode 0, Mode 1, Mode 2, Mode 3, and Mode 4.

#### Primary Master/Slave UltraDMA

UDMA (Ultra DMA) is a DMA data transfer protocol that utilizes ATA commands and the ATA bus to allow DMA commands to transfer data at a maximum burst rate of 33 MB/s. When you select *Auto* in the four IDE UDMA fields (for each of up to four IDE devices that the internal PCI IDE interface supports), the system automatically determines the optimal data transfer rate for each IDE device.

The choice: Auto, Disabled.

#### IDE Burst Mode

Selecting *Enabled* reduces latency between each drive read/write cycle, but may cause instability in IDE subsystems that cannot support such fast performance. If you are getting disk drive errors, try setting this value to *Disabled*. This field does not appear when the Internal PCI/IDE field, above, is *Disabled*.

The choice: Enabled, Disabled.

### SIS 630 OnChip PCI Device

#### SIS-7018 AC97 AUDIO

Select *Enabled* to support AC97 Audio.

The choice: Enabled, Disabled.

#### SIS-900 10/100M ETHERNET

This item provides a total communication solution including 10/100Mb Fast Ethernet for Office requirement and 1Mb HomePNA for Home Networking. The choice: Enabled, Disabled.

## Super I/O Device

---

### Onboard FDC Controller

Select Enabled if your system has a floppy disk controller (FDC) installed on the system board and you wish to use it. If you install and-in FDC or the system has no floppy drive, select Disabled in this field.

The choice: Enabled, Disabled.

---

### Onboard Serial Port 1/ Port 2 / Port 3 / Port 4

Select an address and corresponding interrupt for the first and second serial ports.

The choice: 3F8/IRQ4, 2E8/IRQ3, 3E8/IRQ4, 2F8/IRQ3, Disabled, Auto.

---

### UART Mode Select

This item allows you to select UART mode.

The choice: Enabled, Disabled.

---

### UR2 Duplex Mode

This item allows you to select the IR half/full duplex function.

The choice: Half, Full.

---

### Onboard Parallel Port 1 / Port 2

This item allows you to determine access onboard parallel port controller with which I/O address.

The choice: 3BC/IRQ7, 378/IRQ7, 278/IRQ5, Disabled.

---

### Parallel Port Mode

Select an operating mode for the onboard parallel (printer) port. Select *Normal*, *Compatible*, or *SPP* unless you are certain your hardware and software both support one of the other available modes.

---

The choice: SPP, EPP, ECP, ECP+EPP.

---

### ECP Mode Use DMA

Select a DMA channel for the parallel port for use during ECP mode.

The choice: 3, 1.

---

### USB Controller

Select *Enabled* if your system contains a Universal Serial Bus (USB) controller and you have USB peripherals.

Choices are: Enabled, Disabled.

---

### USB Keyboard Support

Select *Enabled* if your system contains a Universal Serial Bus (USB) controller and you have a USB keyboard.

Choices are: Enabled, Disabled.

---

### IDE HDD Block Mode

Block mode is also called block transfer, multiple commands, or multiple sector read/write. If your IDE hard drive supports block mode (most new drives do), select Enabled for automatic detection of the optimal number of block read/writes per sector the drive can support.

The choice: Enabled, Disabled.

---

### Init Display First

This item allows you to decide to active which bus first (PCI Slot or AGP first).

The choice: PCI Slot, AGP.

---

### System Share Memory Size

This item defines the System Share Memory Size for video.

The choice: 2MB, 4MB, 16MB, 32MB, 64MB, 2+2MB, 4+4MB, 8+8MB, 16+16MB, 32+32MB

---

The choice: Enabled, Disabled.

---

### ACPI Suspend Type

This item allows you to S1(Power ON Suspend)/S3(Suspend To RAM) the Advanced Configuration and Power Management (ACPI).  
The choice: S1(POS), S3(STR).

---

### Video Off Option

When enabled, this feature allows the VGA adapter to operate in a power saving mode.

Always On	Monitor will remain on during power saving modes.
Suspend Off -->	Monitor blanked when the systems enters the Suspend mode.
Susp,Stby -->	Monitor blanked when the system enters either Suspend or Standby modes.
All Modes Off -->	Monitor blanked when the system enters any power saving mode.

---

### Video Off Method

This determines the manner in which the monitor is blanked.

V/H SYNC+Blank	This selection will cause the system to turn off the vertical and horizontal synchronization ports and write blanks to the video buffer.
Blank Screen	This option only writes blanks to the video buffer.
DPMS	Select this option if your monitor supports the Display Power Management Signaling (DPMS) standard of the Video Electronics Standards to select video power management values.

## 4.10 Power Management Setup

The Power Management Setup allows you to configure you system to most effectively save energy while operating in a manner consistent with your own style of computer use.

CMOS Setup Utility – Copyright © 1984 – 1998 Award Software  
Power Management Setup

ACPI function	Enabled	Item Help
ACPI Suspend Type	S3(STR)	
Video Off Option	Susp,Stby -> Off	
Video Off Method	V/H	Menu Level >
SYNC_Blank		
Switch Function	Break/Wake	
Hot Key Function As	Power Off	
HDD Off After	Disable	
Power Button Override	Instant Off	
KB Power On Password	Disable	
PM Wake Up Events	Press Enter	
Power Up by Alarm	Press Enter	
↑↓←→Move Enter: Select +/-/PU/PD: Value F10:Save ESC: Exit F1:General Help F5:Previous Values F6:Fail-safe defaults F7:Optimized Defaults		

---

### ACPI Function

This item allows you to enable/disable the Advanced Configuration and Power Management (ACPI).

---

## Switch Function

You can choose whether or not to permit your system to enter complete Suspend mode. Suspend mode offers greater power savings, with a correspondingly longer awakening period..

The choice: Break/Wake, Disabled.

---

## Hot Key Function As

Select *Enabled* if your system has a hot key for soft power off.

The choice: Enabled, Disabled.

---

## HDD Off After

By default, this item is Disabled, meaning that no matter the mode the rest of the system, the hard drive will remain ready. Otherwise, you have a range of choices from 1 to 15 minutes or Suspend. This means that you can elect to have your hard disk drive be turned off after a selected number of minutes or when the rest of the system goes into a Suspend mode.

---

## Power Button Over Ride

You could press the power button for more than 4 seconds forces the system to enter the Soft-Off state when the system has “hung.”

The choice: Soft-Off, Delay 4 Sec.

---

## PM Wake Up Events

---

### IRQ [3-7,9-15],NMI

The following is a list of IRQ's, Interrupt **Re**Quests, which can be exempted much as the COM ports and LPT ports above can. When an I/O device wants to gain the attention of the operating system, it signals this by causing an IRQ to occur. When the operating system is ready to respond to the request, it interrupts itself and performs the service.

As above, the choices are *On* and *Off*.

When set *On*, activity will neither prevent the system from going into a power management mode nor awaken it.

- **IRQ [ 3-7, 9-15], NMI**
- **IRQ 8 Break Suspend** : You can *Enable* or *Disable* monitoring of IRQ8 (the Real Time Clock) so it does not awaken the system from Suspend mode.

---

## Ring / PCIPME Power Up Control

When you select *Enabled*, a signal from ring / PCIPME returns the system to Full On state.

The choice: Enabled, Disabled.

---

## KB Power On Password

This item can be used to prompt the used for a password when the system power is resumed by keyboard action .

The choice: Disable , Enable.

---

## Power Up by Alarm

When you select *Enabled*, the following fields appear. They let you set the alarm that returns the system to Full On state.

Date ( of Month ) Alarm lets you select a day from 1 to 31 . Time Alarm lets you select a time for the alarm in hours , minutes , and seconds .

The choice: Enabled, Disabled.



## 4.11 PnP/PCI Configuration Setup

This section describes configuring the PCI bus system. PCI, or Personal Computer Interconnect, is a system which allows I/O devices to operate at speeds nearing the speed the CPU itself uses when communicating with its own special components. This section covers some very technical items and it is strongly recommended that only experienced users should make any changes to the default settings.

CMOS Setup Utility – Copyright © 1984-1998 Award Software  
PnP/PCI Configurations

Reset Configuration Data <b>Disabled</b>	Item Help ----- Menu Level ➤
Resources Controlled By Auto(ESCD)	Default is Disabled. Select Enabled to reset Extended System Configuration Data(ESCD) when you exit Setup if you have installed a new add-on and the system reconfiguration has caused such a serious conflict that the OS cannot boot
➤ IRQ Resources      Press Enter	
PCI/VGA Palette Snoop    Disabled	
↑↓←→Move    Enter: Select    +/-/PU/PD: Value    F10:Save    ESC: Exit F1:General Help F5:Previous Values    F6:Fail-safe defaults    F7:Optimized Defaults	

### Reset Configuration Data

Normally, you leave this field Disabled. Select Enabled to reset Extended System Configuration Data (ESCD) when you exit Setup if you have installed a new add-on and the system reconfiguration has caused such a serious conflict that the operating system can not boot. The choice: Enabled, Disabled .

### Resource controlled by

The Award Plug and Play BIOS has the capacity to automatically configure all of the boot and Plug and Play compatible devices. However, this capability means absolutely nothing unless you are using a Plug and Play operating system such as Windows®95. If you set this field to “manual” choose specific resources by going into each of the sub menu that follows this field (a sub menu is preceded by a “➤”). The choice: Auto(ESCD), Manual.

### IRQ Resources

When resources are controlled manually, assign each system interrupt a type, depending on the type of device using the interrupt.

**IRQ3/4/5/7/9/10/11/12/14/15 assigned to**

This item allows you to determine the IRQ assigned to the ISA bus and is not available to any PCI slot. Legacy ISA for devices compliant with the original PC AT bus specification, PCI/ISA PnP for devices compliant with the Plug and Play standard whether designed for PCI or ISA bus architecture.

The Choice: *Legacy ISA and PCI/ISA PnP.*

**PCI/VGA Palette Snoop**

Leave this field at *Disabled*.

Choices are Enabled, Disabled.

**4.12 PC Health Status**

This section helps you to get more information about your system including CPU temperature, FAN speed and voltages. It is recommended that you contact with your motherboard supplier to get proper value about your setting of the CPU temperature.

CMOS Setup Utility – Copyright © 1984-1998 Award Software  
PC Health Status

Voltage 0	1.65V	Item Help ----- Menu Level >
Voltage 1	2.49V	
Voltage 2	3.37V	
Voltage 3	4.97V	
Voltage 4	11.96V	
Voltage 5	3.29V	
Voltage 6	-11.45V	
Voltage 7	4.65V	
Voltage Battery	2.91V	
Temperature1	- 55°C	
Temperature2	40°C	
Temperature3	79°C	
FAN 1 Speed	4153 RPM	
FAN 2 Speed	0 RPM	
↑↓←→ Move Enter: Select +/-/PU/PD: Value F10:Save ESC: Exit F1:General Help F5:Previous Values F6:Fail-safe defaults F7:Optimized Defaults		

**Voltage 0/1/2/3/4/5/6/7**

The chipset reserves 8 inputs for monitoring working voltages from various sources in the system. These voltages may include CPU voltage, power pins of the ATX power (+/-12V, +/-5V, 3.3V...) and others.

Generic names (Voltage 0-9) are given to these items because where these pins are connected depends on different platforms you are using.

**Voltage Battery**

Monitor the output voltage of the a RTC battery.

**Temperature 1/2/3**

The chipset reserves 3 inputs for monitoring temperatures that are typically the CPU & system temperatures.

Generic names are given for the same reason as Voltage 0-7.

---

## Fan 1/2 Speed

The chipset reserves 2 inputs for monitoring FAN speeds in the system. Usually, one FAN is applied to cool down the CPU and the other one is applied by different purpose.

Generic names are given for the same reason as Voltage 0-7.

Auto Detect DIMM/PCI Clk	Disabled	Item Help
Spread Spectrum	Disabled	-----
CPU HOST/SDRAM/PCI Clock	Default	Menu Level >
CPU Clock Ratio	By H/W	

---

↑↓←→ Move Enter: Select +/-/PU/PD: Value F10:Save ESC: Exit  
F1:General Help  
F5:Previous Values F6:Fail-safe defaults F7:Optimized Defaults

---

## Auto Detect DIMM/PCI CLK

This item allows you to enable/disable auto detect DIMM/PCI Clock.  
The choice: Enabled, Disabled.

---

## Spread Spectrum

This item allows you to enable/disable the spread spectrum modulate.  
The choice: Enabled, Disabled.

---

## CPU Host/DRAM/PCI Clock

This item allows you to select CPU/PCI frequency.  
The choice: Default, 66/66/33MHz, 133/133/33MHz, 100/100/33MHz.

---

## CPU Clock Ratio

This item allows you to select CPU clock ratio.

## 4.13 Frequency/Voltage Control

CMOS Setup Utility – Copyright © 1984-1998 Award Software  
Frequency/Voltage Control

The choice: By H/W 3, 3.5, 4, 4.5, 5, 5.5, 6, 6.5, 7, 7.5, 8.

## 4.14 Defaults Menu

Selecting “Defaults” from the main menu shows you two options which are described below

### Load Fail-Safe Defaults

When you press <Enter> on this item you get a confirmation dialog box with a message similar to:

Load Fail-Safe Defaults (Y/N) ? **N**

Pressing ‘Y’ loads the BIOS default values for the most stable, minimal-performance system operations.

### Load Optimized Defaults

When you press <Enter> on this item you get a confirmation dialog box with a message similar to:

Load Optimized Defaults (Y/N) ? **N**

Pressing ‘Y’ loads the default values that are factory settings for optimal performance system operations.

You can set either supervisor or user password, or both of them. The differences between are:

### supervisor password :

can enter and change the options of the setup menus.

### user password :

just can only enter but do not have the right to change the options of the setup menus. When you select this function, the following message will appear at the center of the screen to assist you in creating a password.

### ENTER PASSWORD:

Type the password, up to eight characters in length, and press <Enter>. The password typed now will clear any previously entered password from CMOS memory. You will be asked to confirm the password. Type the password again and press <Enter>. You may also press <Esc> to abort the selection and not enter a password.

To disable a password, just press <Enter> when you are prompted to enter the password. A message will confirm the password will be disabled. Once the password is disabled, the system will boot and you can enter Setup freely.

### PASSWORD DISABLED.

When a password has been enabled, you will be prompted to enter it every time you try to enter Setup. This prevents an unauthorized person from changing any part of your system configuration.

Additionally, when a password is enabled, you can also require the BIOS to request a password every time your system is rebooted. This would prevent unauthorized use of your computer.

You determine when the password is required within the BIOS Features Setup Menu and its Security option (see Section 3). If the Security option is set to password will be required both at boot and at entry to Setup. If set to “Setup”, prompting only occurs when trying to enter Setup.

## 4.15 Supervisor/User Password Setting

## 4.16 Exit Selecting

### Save & Exit Setup

Pressing <Enter> on this item asks for confirmation:

**Save to CMOS and EXIT (Y/N)?** **Y**

Pressing “Y” stores the selections made in the menus in CMOS – a special section of memory that stays on after you turn your system off. The next time you boot your computer, the BIOS configures your system according to the Setup selections stored in CMOS. After saving the values the system is restarted again.

### Exit Without Saving

Pressing <Enter> on this item asks for confirmation:

**Quit without saving (Y/N)?** **Y**

This allows you to exit Setup without storing in CMOS any change. The previous selections remain in effect. This exits the Setup utility and restarts your computer.

## Appendix A. Watch-Dog Timer

The Watchdog Timer is a device to ensure that standalone systems can always recover from abnormal conditions that cause the system to crash. These conditions may result from an external EMI or a software bug. When the system stops working, hardware on the board will perform hardware reset (cold boot) to bring the system back to a known state.

Three I/O ports control the operation of Watch-Dog Timer.

443 (hex)	Write	Set Watchdog Time period
443 (hex)	Read	Enable the refresh the Watchdog Timer.
043/843 (hex)	Read	Disable the Watch-Dog Timer.

Prior to enable the Watch-Dog Timer, user has to set the time-out period. The resolution of the timer is 1 second and the range of the timer is from 1 sec to 255 sec. You need to send the time-out value to the I/O port – 443H, and then enable it by reading data from the same I/O port – 443H. This will activate the timer that will eventually time out and reset the CPU board. To ensure that this reset condition won't occur, the Watch-Dog Timer must be periodically refreshed by reading the same I/O port 443H. This must be done within the time-out period, please refer to the example program. Finally, we have to disable the Watch-Dog timer by reading the I/O port -- 843H or 043H. Otherwise the system could reset unconditionally.

A tolerance of at least 5% must be maintained to avoid unknown routines in the operating system (DOS), such as disk I/O that can be very time-consuming. Therefore if the time-out period has been set to 10 seconds, the I/O port 443H must be read within 7 seconds.

**Example assembly program:**

```
TIMER_PORT = 443H
TIMER_START = 443H
TIMER_STOP = 843H
```

**;;INITIAL TIMER COUNTER**

```
MOV DX, TIMER_PORT
MOV AL, 8 ;;8 seconds
OUT DX, AL
MOV DX, TIMER_START
IN AL, DX. ;;start counter
```

```
W_LOOP:
MOV DX, TIMER_STOP
IN AL, DX
MOV DX, TIMER_START
IN AL, DX ;;restart counter
```

**;;ADD YOUR APPLICATION HERE**

```
CMP EXIT_AP, 0
JNE W_LOOP
MOV DX, TIMER_STOP
IN AL, DX
;;EXIT AP
```

## Appendix B. POST Messages

### *POST Messages*

During the Power On Self Test (POST), if the BIOS detects an error requiring you to do something to fix, it will either sound a beep code or display a message. If a message is displayed, it will be accompanied by:  
PRESS F1 TO CONTINUE, CTRL-ALT-ESC OR DEL TO ENTER SETUP

### POST Beep

Currently there are two kinds of beep codes in BIOS. This code indicates that a video error has occurred and the BIOS cannot initialize the video screen to display any additional information. This beep code consists of a single long beep followed by three short beeps. The other code indicates that your DRAM error has occurred. This beep code consists of a single long beep repeatedly.

### Error Messages

One or more of the following messages may be displayed if the BIOS detects an error during the POST. This list includes messages for both the ISA and the EISA BIOS.

#### **CMOS BATTERY HAS FAILED**

CMOS battery is no longer functional. It should be replaced.

#### **CMOS CHECKSUM ERROR**

Checksum of CMOS is incorrect. This can indicate that CMOS has become corrupt. This error may have been caused by a weak battery. Check the battery and replace if necessary.

#### **DISK BOOT FAILURE, INSERT SYSTEM DISK AND PRESS ENTER**

No boot device was found. This could mean that either a boot drive was not detected or the drive does not contain proper system boot files. Insert a system disk into Drive A: and press <Enter>. If you assumed the system would boot from the hard drive, make sure the controller is inserted correctly and all cables are properly attached. Also be sure the disk is formatted as a boot device. Then reboot the system.

#### **DISKETTE DRIVES OR TYPES MISMATCH ERROR - RUN SETUP**

Type of diskette drive installed in the system is different from the CMOS definition. Run Setup to reconfigure the drive type correctly.

#### **DISPLAY SWITCH IS SET INCORRECTLY**

Display switch on the motherboard can be set to either monochrome or color. This indicates the switch is set to a different setting than indicated in Setup. Determine which setting is correct, and then either turn off the system and change the jumper, or enter Setup and change the VIDEO selection.

#### **DISPLAY TYPE HAS CHANGED SINCE LAST BOOT**

Since last powering off the system, the display adapter has been changed. You must configure the system for the new display type.

#### **EISA Configuration Checksum Error PLEASE RUN EISA CONFIGURATION UTILITY**

The EISA non-volatile RAM checksum is incorrect or cannot correctly read the EISA slot. This can indicate either the EISA non-volatile memory has become corrupt or the slot has been configured incorrectly. Also be sure the card is installed firmly in the slot.

#### **EISA Configuration Is Not Complete PLEASE RUN EISA CONFIGURATION UTILITY**

The slot configuration information stored in the EISA non-volatile memory is incomplete.

**Note:** When either of these errors appear, the system will boot in ISA mode, which allows you to run the EISA Configuration Utility.

#### **ERROR ENCOUNTERED INITIALIZING HARD DRIVE**

Hard drive cannot be initialized. Be sure the adapter is installed correctly and all cables are correctly and firmly attached. Also be sure the correct hard drive type is selected in Setup.

#### **ERROR INITIALIZING HARD DISK CONTROLLER**

Cannot initialize controller. Make sure the cord is correctly and firmly installed in the bus. Be sure the correct hard drive type is selected in Setup. Also check to see if any jumper needs to be set correctly on the hard drive.

#### **FLOPPY DISK CNTRLR ERROR OR NO CNTRLR PRESENT**

Cannot find or initialize the floppy drive controller. make sure the controller is installed correctly and firmly. If there are no floppy drives installed, be sure the Diskette Drive selection in Setup is set to NONE.

#### **Invalid EISA Configuration PLEASE RUN EISA CONFIGURATION UTILITY**

The non-volatile memory containing EISA configuration information was programmed incorrectly or has become corrupt. Re-run EISA configuration utility to correctly program the memory.

**NOTE:** When this error appears, the system will boot in ISA mode, which allows you to run the EISA Configuration Utility.

#### **KEYBOARD ERROR OR NO KEYBOARD PRESENT**

Cannot initialize the keyboard. Make sure the keyboard is attached correctly and no keys are being pressed during the boot. If you are purposely configuring the system without a keyboard, set the error halt condition in Setup to HALT ON ALL, BUT KEYBOARD. This will cause the BIOS to ignore the missing keyboard and continue the boot.

#### **Memory Address Error at ...**

Indicates a memory address error at a specific location. You can use this location along with the memory map for your system to find and replace the bad memory chips.

#### **Memory parity Error at ...**

Indicates a memory parity error at a specific location. You can use this location along with the memory map for your system to find and replace the bad memory chips.

#### **MEMORY SIZE HAS CHANGED SINCE LAST BOOT**

Memory has been added or removed since the last boot. In EISA mode use Configuration Utility to reconfigure the memory configuration. In ISA mode enter Setup and enter the new memory size in the memory fields.

#### **Memory Verify Error at ...**

Indicates an error verifying a value already written to memory. Use the location along with your system's memory map to locate the bad chip.

#### **OFFENDING ADDRESS NOT FOUND**

This message is used in conjunction with the I/O CHANNEL CHECK and RAM PARITY ERROR messages when the segment that has caused the problem cannot be isolated.

#### **OFFENDING SEGMENT:**

This message is used in conjunction with the I/O CHANNEL CHECK and RAM PARITY ERROR messages when the segment that has caused the problem has been isolated.

#### **PRESS A KEY TO REBOOT**

This will be displayed at the bottom screen when an error occurs that requires you to reboot. Press any key and the system will reboot.

#### **PRESS F1 TO DISABLE NMI, F2 TO REBOOT**

When BIOS detects a Non-maskable Interrupt condition during boot, this will allow you to disable the NMI and continue to boot, or you can reboot the system with the NMI enabled.

#### **RAM PARITY ERROR - CHECKING FOR SEGMENT ...**

Indicates a parity error in Random Access Memory.

#### **Should Be Empty But EISA Board Found PLEASE RUN EISA CONFIGURATION UTILITY**

A valid board ID was found in a slot that was configured as having no board ID.

**NOTE;** When this error appears, the system will boot in ISA mode, which allows you to run the EISA Configuration Utility.

#### **Should Have EISA Board But Not Found PLEASE RUN EISA CONFIGURATION UTILITY**

The board installed is not responding to the ID request, or no board ID has been found in the indicated slot.

**NOTE:** When this error appears, the system will boot in ISA mode, which allows you to run the EISA Configuration Utility.

#### **Slot Not Empty**

Indicates that a slot designated as empty by the EISA Configuration Utility actually contains a board.

**NOTE:** When this error appears, the system will boot in ISA mode, which allows you to run the EISA Configuration Utility.

#### **SYSTEM HALTED, (CTRL-ALT-DEL) TO REBOOT ...**

Indicates the present boot attempt has been aborted and the system must be rebooted. Press and hold down the CTRL and ALT keys and press DEL.

#### **Wrong Board In Slot PLEASE RUN EISA CONFIGURATION UTILITY**

The board ID does not match the ID stored in the EISA non-volatile memory.

**NOTE:** When this error appears, the system will boot in ISA mode, which allows you to run the EISA Configuration Utility.

#### **FLOPPY DISK(S) fail (80) → Unable to reset floppy subsystem.**



**FLOPPY DISK(S) fail (40)** → Floppy Type mismatch.

**Hard Disk(s) fail (80)** → HDD reset failed

**Hard Disk(s) fail (40)** → HDD controller diagnostics failed.

**Hard Disk(s) fail (20)** → HDD initialization error.

**Hard Disk(s) fail (10)** → Unable to recalibrate fixed disk.

**Hard Disk(s) fail (08)** → Sector Verify failed.

**Keyboard is locked out - Unlock the key.**

BIOS detect the keyboard is locked. P17 of keyboard controller is pulled low.

**Keyboard error or no keyboard present.**

Cannot initialize the keyboard. Make sure the keyboard is attached correctly and no keys are being pressed during the boot.

**Manufacturing POST loop.**

System will repeat POST procedure infinitely while the P15 of keyboard controller is pull low. This is also used for M/B burn in test.

**BIOS ROM checksum error - System halted.**

The checksum of ROM address F0000H-FFFFFH is bad.

**Memory test fail.**

BIOS reports the memory test fail if the onboard memory is tested error.

## Appendix C.

### DMA, IRQ and 1<sup>st</sup> MB Memory

#### I/O Address Map

##### DMA Channel Assignments:

DMA Channel #	Description
0	Available
1	Available
2	Floppy Disk (8-bit transfer)
3	Available
4	Cascade for DMA controller 1
5	Sound
6	Available
7	Available

##### IRQ Mapping Chart

IRQ0	System Timer	IRQ8	RTC Clock
IRQ1	Keyboard	IRQ9	USB
IRQ2	Cascade to IRQ Controller	IRQ10	LAN1

IRQ3	(COM2)	IRQ11	LAN2
IRQ4	(COM1)	IRQ12	PS/2 Mouse
IRQ5	Sound	IRQ13	FPU
IRQ6	FDC	IRQ14	Primary IDE
IRQ7	LPT1	IRQ15	Secondary IDE

**Note:** All IRQs have been assigned to the listed devices, so if you want to add any additional device interface, you must free the unused IRQ first. For example, if you don't use USB K/B or Mouse, then IRQ9 may be set free.

378-37F	Parallel Printer Port 1 (LPT1)
380-38F	SDLC, Bisynchronous 2
3A0-3AF	Bisynchronous 1
3B0-3BB	SIS 630
3C0-3DF	SIS 630
3F0-3F7	Diskette Controller
3F8-3FF	Serial Port 1 (COM1)
443, 843	Watch-dog timer

### 1<sup>st</sup> MB Memory Address Map

Memory Address	Description
00000-9FFFF	System Board extension for ACPI BIOS
A0000-CFFFF	SIS630
D0000-DFFFF	Free
F0000-FFFFFF	System Board extension for ACPI BIOS

### I/O Address Map

I/O Address Range	Description
000-01F	DMA Controller #1
020-021	Interrupt Controller #1, Master
040-05F	8254 Timer
060-06F	8042 (Keyboard Controller)
070-07F	Real Time Clock, NMI Mask
080-09F	DMA Page Register
0A0-0BF	Interrupt Controller #2
0C0-0DF	DMA Controller #2
0F0	Clear Math Coprocessor Busy
0F1	Reset Math Coprocessor
0F8-0FF	Math Coprocessor
170-177	Fixed Disk
1F0-1F7	
2F8-2FF	Serial Port 2 (COM2)

## Appendix D.

### How to Upgrade a New BIOS

You can install an upgrade BIOS for the CPU Board that you can download from the manufacturer's web site ( [www.iei.com.tw](http://www.iei.com.tw) ). New BIOS may provide support for new peripherals ,improvements in performance or fixes to addressed known bugs.

BIOS Update Procedure:

1. Make a boot disk. Go to the DOS command prompt in MS-DOS or Windows 9x and, with an available floppy disk in "A", type "format A: /s" That will format the floppy and transfer the needed system files to it.

NOTES:

- A. This procedure will erase any prior data on that floppy, so please Proceed accordingly.
- B. Typically four files will be transferred, only COMMAND.COM

being visible when running a simple directory listing.

C. Please leave the diskette UN-write protected for the balance of this procedure.

2. Download the BIOS upgrade file and awdflash.exe utility from a ICP web site to a temp directory on your hard drive, or directly to the floppy you made in step 1..

3. Copy ( BIOS file and awdflash.exe )two files to the boot floppy.

4. Reboot the system to the DOS command prompt using the boot diskette you just made.

5. At the DOS command prompt, type "awdflash filename.xxx", where filename.xxx is the file name of the BIOS file . Hit enter.

6. Your first option, in sequence, will be to save the old BIOS. We recommend that you do that in case, for whatever reason, you decide you don't wish to use the new version once it is installed.

NOTES:

A. If you decide to save the old BIOS, PLEASE make sure you do NOT save it to the same file name as the new BIOS - if you use the same BIOS name the old file will be written over the new file with NO warning prompt. A simple file name to save the old BIOS to is OLDBIOS.BIN.

B. If you do NOT decide to save the old BIOS, PLEASE at least write down the version number of the old BIOS and store that information with your important computer documents. Enter N (for "no") and skip to step 9.

7. To save the old BIOS, hit Y (for "yes")

8. Enter a name for the OLD BIOS file and hit enter.

NOTE:PLEASE be sure you do NOT save the old BIOS file to the

same file name as the new BIOS - if you use the same BIOS name, the old file will write over the new BIOS file WITHOUT a warning prompt. A simple file name for saving the old BIOS to is OLDBIOS.BIN.

9. Your second option, in sequence, will be whether you want to flash your BIOS. Enter Y (for "yes").

NOTE: This is the critical step. Once you kit the enter key, do NOT touch the keyboard, the reset button, or power switch while the flashing is in progress. There will be bar progressing across the screen while the flashing is progressing.

10. When the flashing process is complete, you will be asked to reset or power off the system. Remove the floppy diskette from the floppy drive and either hit the reset button or the power button.

11. Reboot the system and note that the BIOS version on the initial boot-up screen has changed to the new BIOS version. Your BIOS upgrade is now complete.

Recovering Your Old BIOS:

1. Assuming you have the floppy made during the upgrade procedure noted above, boot the system with that diskette in the floppy drive. If you do not have floppy made during the upgrade procedure noted above, you will need to repeat steps 1 though 3 (above) for the version of the BIOS you wish to recover to.

2. Complete steps 4, 5, 6B, 9, 10, and 11 (above) substituting the name of the BIOS you wish to recover for the upgrade BIOS at step 5.

Install screen :

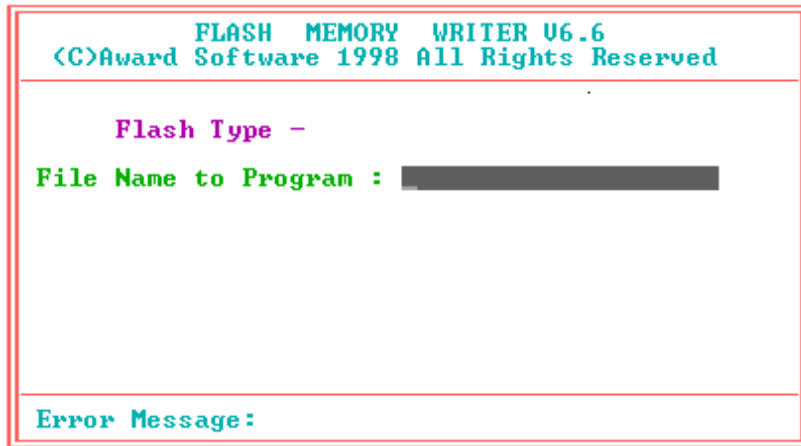

## Appendix E. Digital Input / Output

NOVA-7896/7896FW has 4-bit IN and 4-bit OUT built-in digital I/O connector. An external power supply to the connector's pin-9 and pin-10 is needed to activate the digital I/O circuit. The external power supply's DC output should be connected with NOVA-7896/7896FW's power supply at either 5V, 12V or GND to isolate NOVA-7896/7896FW main system and the external I/O device.

In case that you cannot find any external power supply to activate the digital I/O, the 5V or 12V of the system's power supply can be used. Under this condition, The digital I/O is not isolated.

- Digital Input / Output Address
- Read port 709 : Digital Input

Bit	Value
0 – 3	0 – F

- Write port 708 : Digital Output

Bit	Value
4 – 7	0 – F

**External Voltage Input : 0V – 20V**  
( CN11 Pin 10 )  
**External Power GND Pin**  
( CN11 PIN 9 )

**Digital Input specifications**  
( If External Voltage is 5V )  
Logic 0 Level : +1V Max  
Logic 1 Level : +4V Min

( If External Voltage is 12V )  
Logic 0 Level : +1V max  
Logic 1 Level : +11V min

Input Impedance : 2.7KΩ , 0.5 W

### Digital Output specifications:

Open Drain to 20V Max  
Output Current : 700mA Max ( per channel )  
( External Power Input is 5V )

Output Current : 700mA Max ( per channel )  
( External Power Input is 12V )

### Digital Input / Output Circuit Diagram

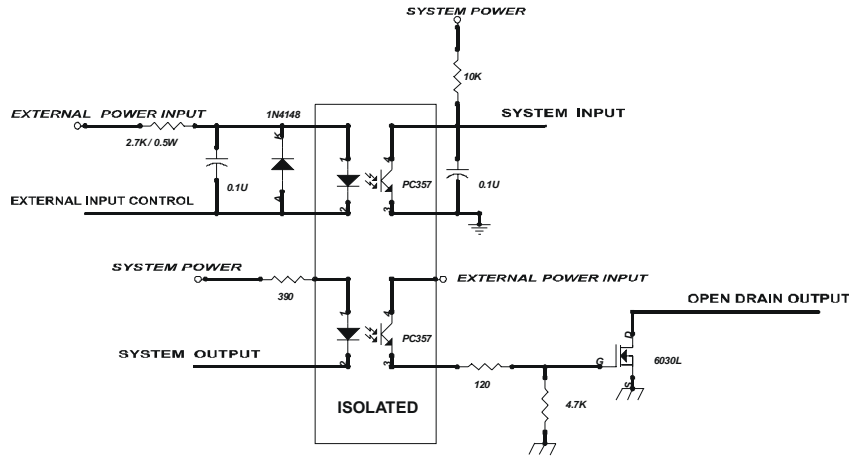

PIN NO.	DESCRIPTION	PIN NO.	DESCRIPTION
1	+12V	2	+12V
3	GND	4	GND
5	3.3V	6	3.3V
7	FPVEE	8	GND
9	P0	10	P1
11	P2	12	P3
13	P4	14	P5
15	P6	16	P7
17	P8	18	P9
19	P10	20	P11
21	P12	22	P13
23	P14	24	P15
25	P16	26	P17
27	P18	28	P19
29	P20	30	P21
31	P22	32	P23
33	GND	34	GND
35	SHFCLK	36	FLM
37	M	38	LP
39	GND	40	ENABKL
41	NC	42	NC
43	FPVDD	44	3.3V

## Appendix F.

### Flat Panel Connection Module

The FP24-02 V1.0 connection module is installed on the NOVA-7896/7896FW as a standard product. The FP24-02 V1.0 converts NOVA-7896/7896FW's on board 50pin LCD interface signal to the 44-pin LCD connectors. The 44-pin connector will only support 24-bit flat panel. The major function of FP24-02 V1.0 is to enhanced the drive strength of LCD signal to provide NOVA-7896/7896FW with a better connection.

• **J3 : 44-pin LCD Interface Connector**

• **J2 : LCD Backlight Power Connector**

PIN NO.	DESCRIPTION
1	N/C
2	GND
3	+12V
4	GND
5	FPVEE Inverter Enable

## FP24-02-V V1.0 Dimension ( Unit : mm )

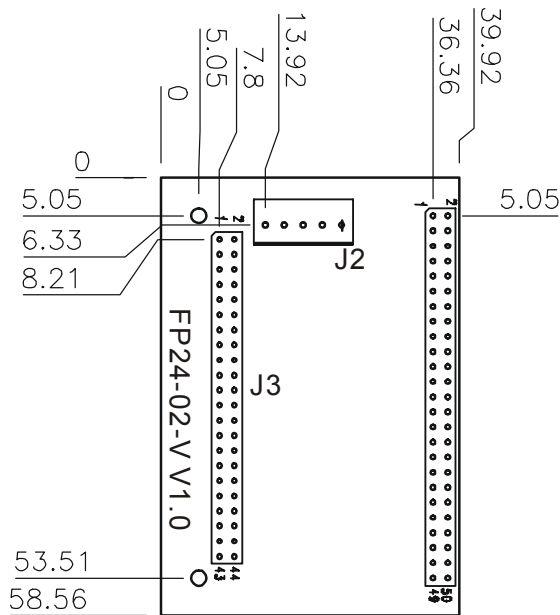

1. Select "Display" in Control Panel and enter "Display Properties".

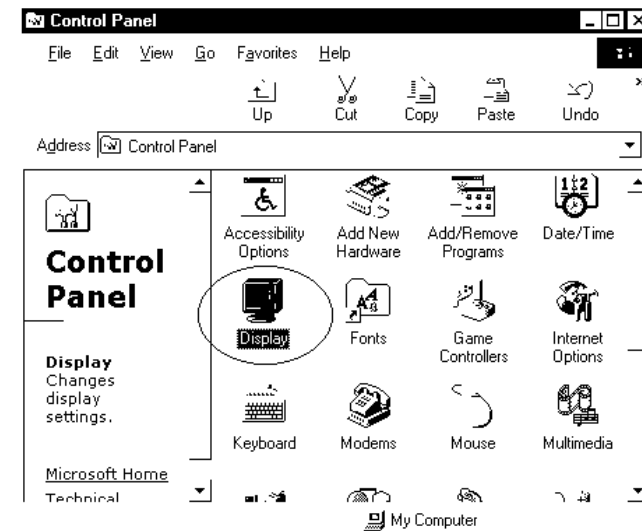

2. Select the item "Settings" and click on the "Advanced" button

## Appendix G. Dual View Setup

The NOVA-7896/7896FW is equipped with a OnChip SIS300 VGA chip which supports dual view function. It allows you to run two applications on two monitors respectively. The following will describe how to enable the dual-view function in WINDOWS.

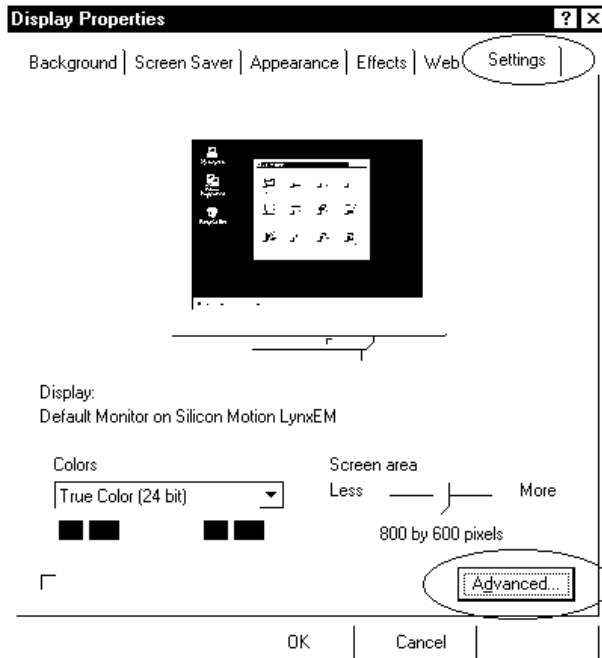

3. Select the item “Display Modes” and click on the “Advanced” button

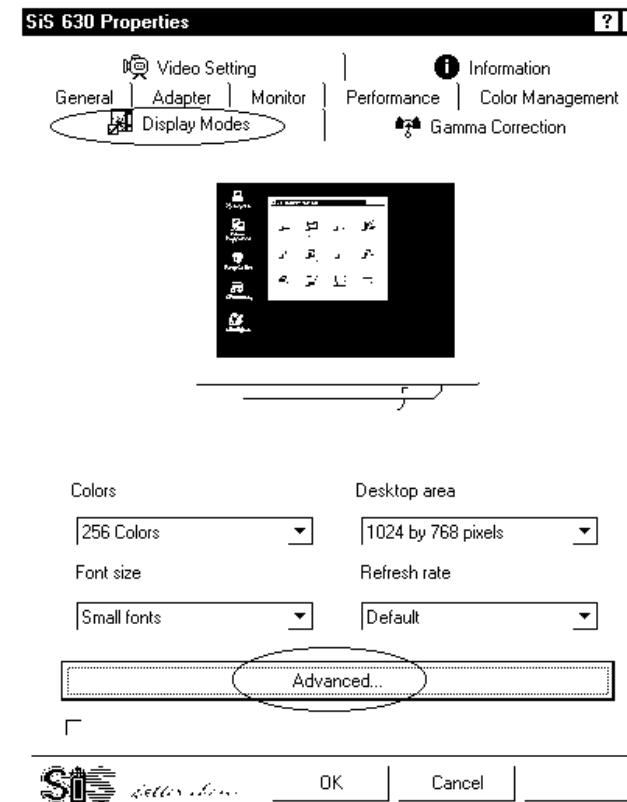

4. Select the item “Multimonitor” in “Driver Mode” and select the Display combination of primary and secondary display.

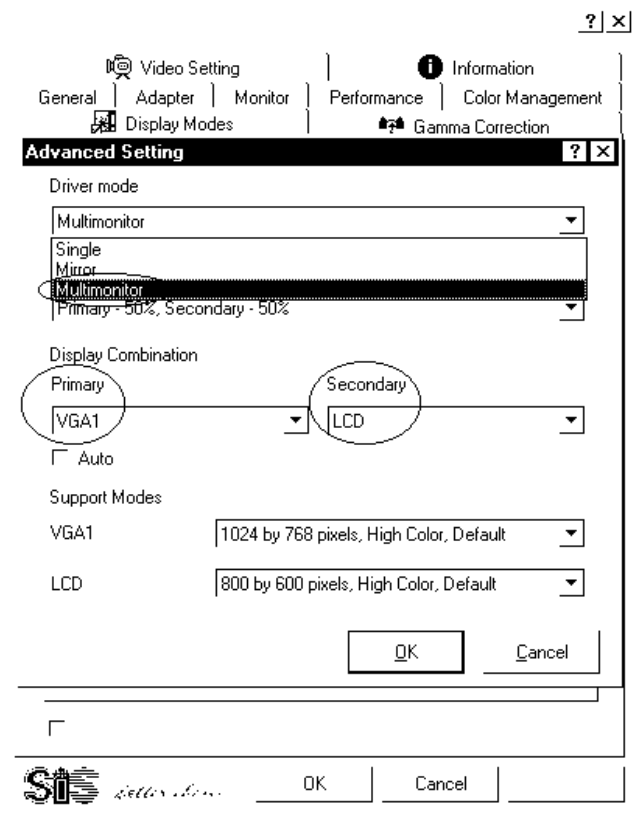

5. After everything is set up, you need to restart your computer to make the new setting take effect.

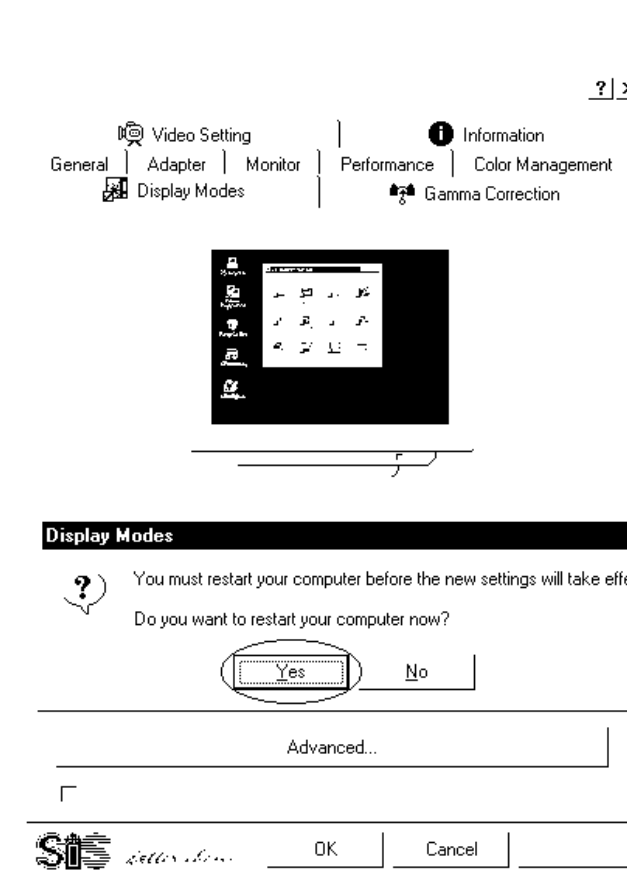



6. Re-enter “Display Properties” and go to the item “Setting”. You will be able to see two monitors showing on the screen.

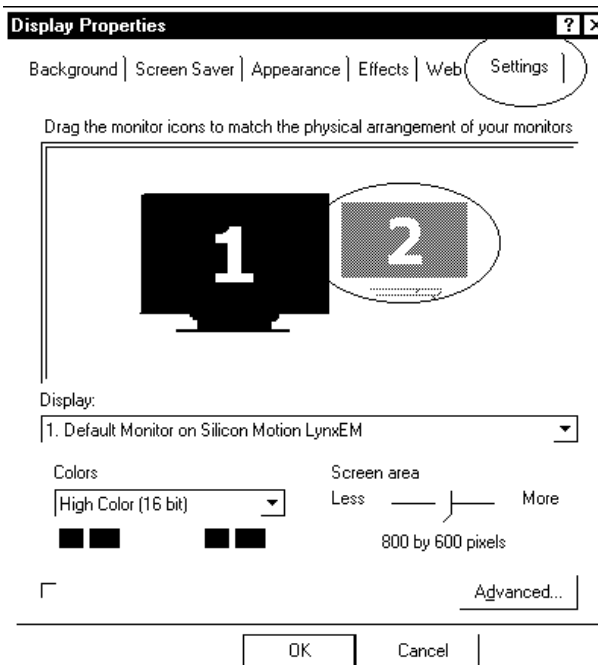

7. Click on the second monitor icon and Windows will ask you if you want to enable the second monitor. Click “Yes” to enable the second monitor .

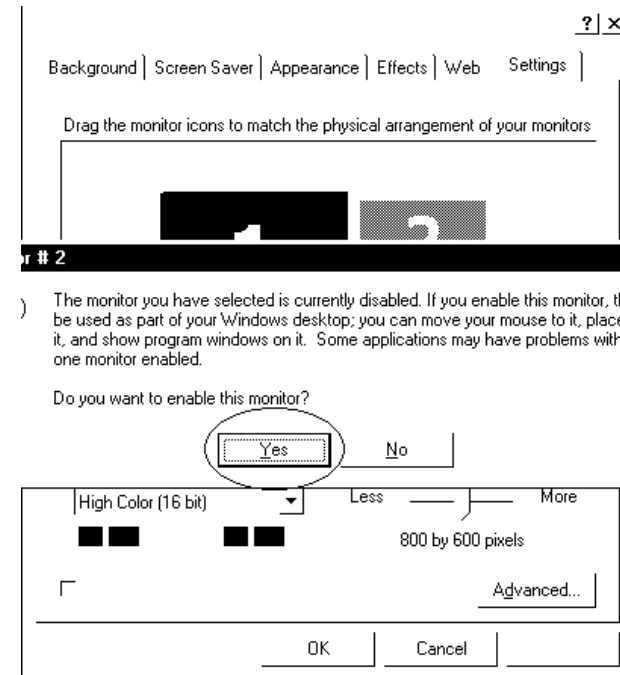

8. After you enable the second monitor, you could see image on the second monitor. Then you can drag the monitor icons to arrange the display of your monitors in the way of left-right or up-down alignment. The screen below is left-and-right alignment.

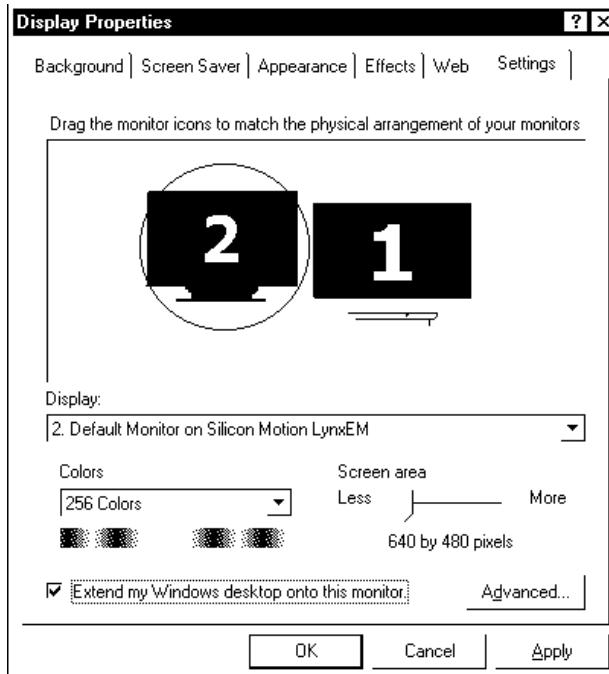

9. Up-and-down alignment.

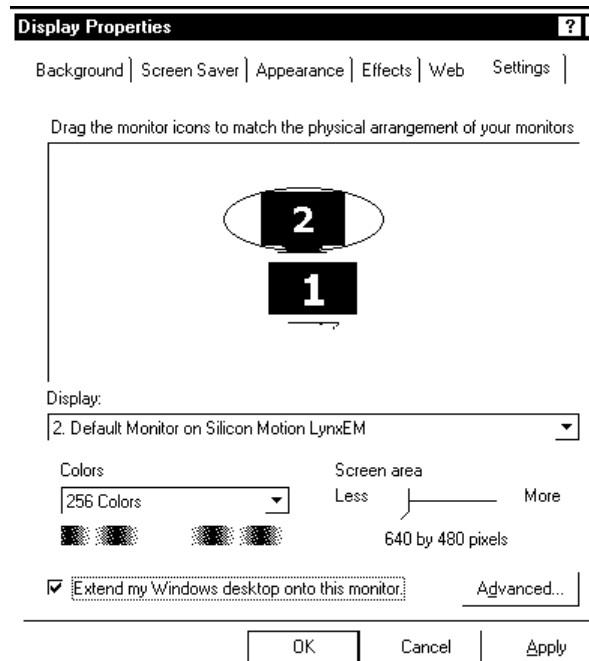

10. If you want to disable the dual-view function, just click on the item “Extend my Windows desktop onto this monitor”. The mark before this item will be canceled and the dual-view function is disabled.

